

# Stabilizacija optičkog rezonatora (na lasersku zraku)

Marin Đujić

Laserska zraka?

Optički rezonator?

Stabilizacija?

# Optički rezonator

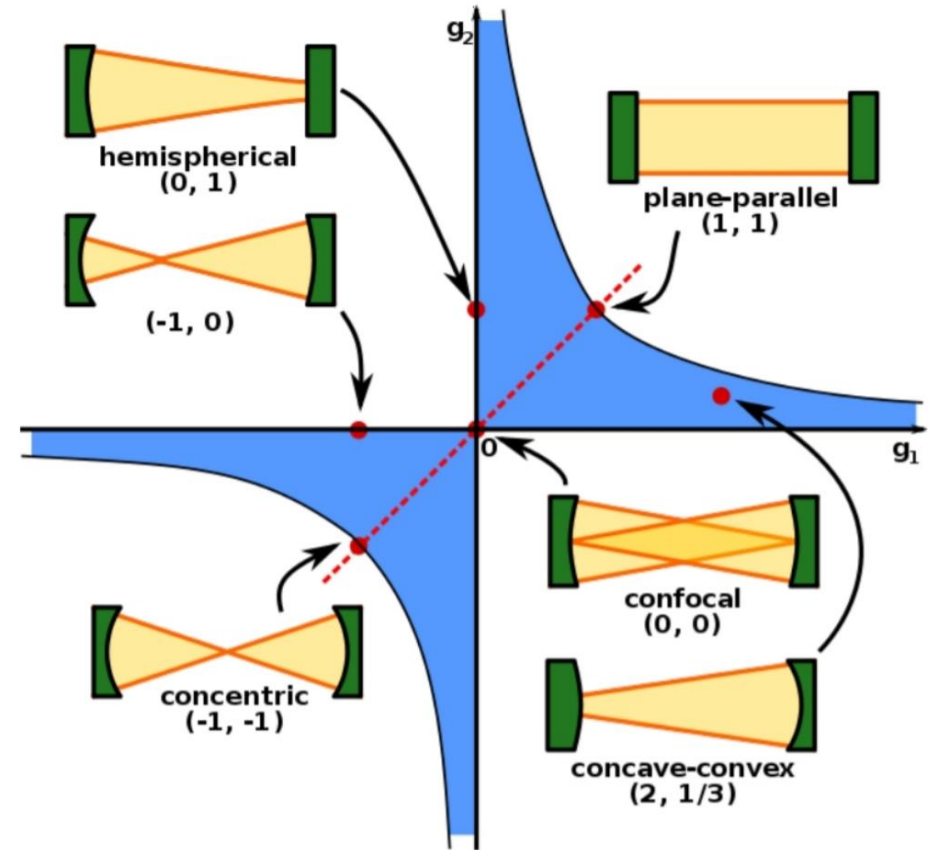
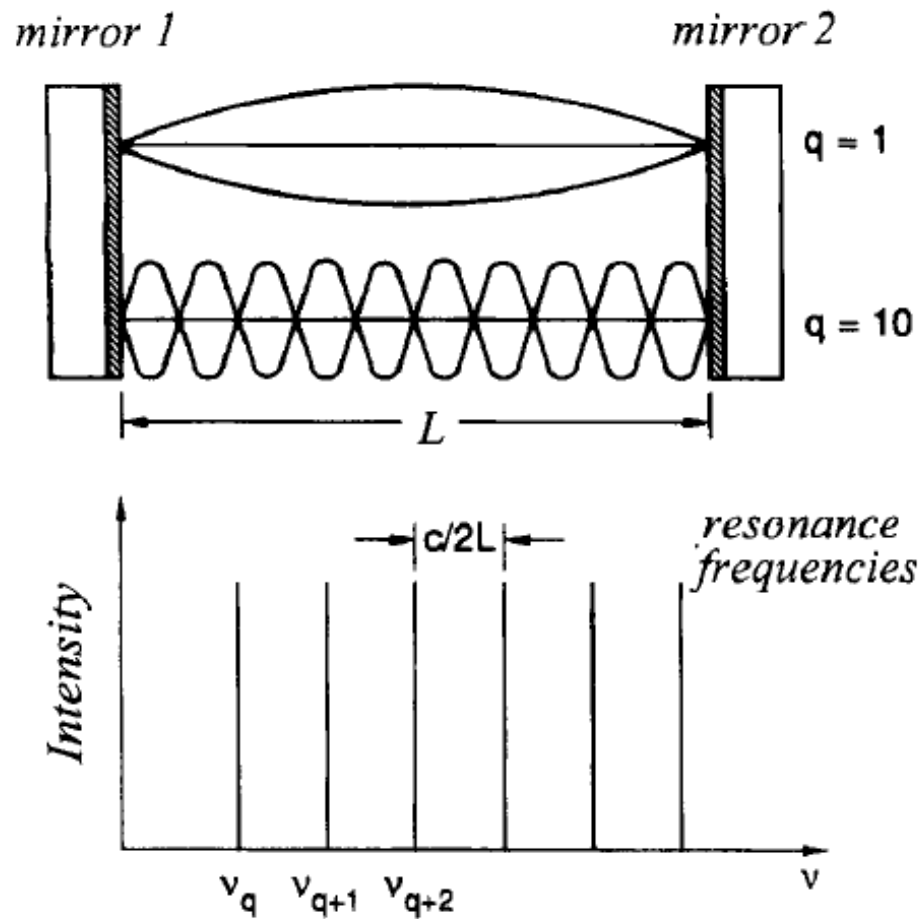

$$g_{1,2} = 1 - \frac{L}{R_{1,2}}$$

# Laserska zraka

$$\left( \nabla_T^2 + 2ik \frac{\partial}{\partial z} \right) \psi = 0$$

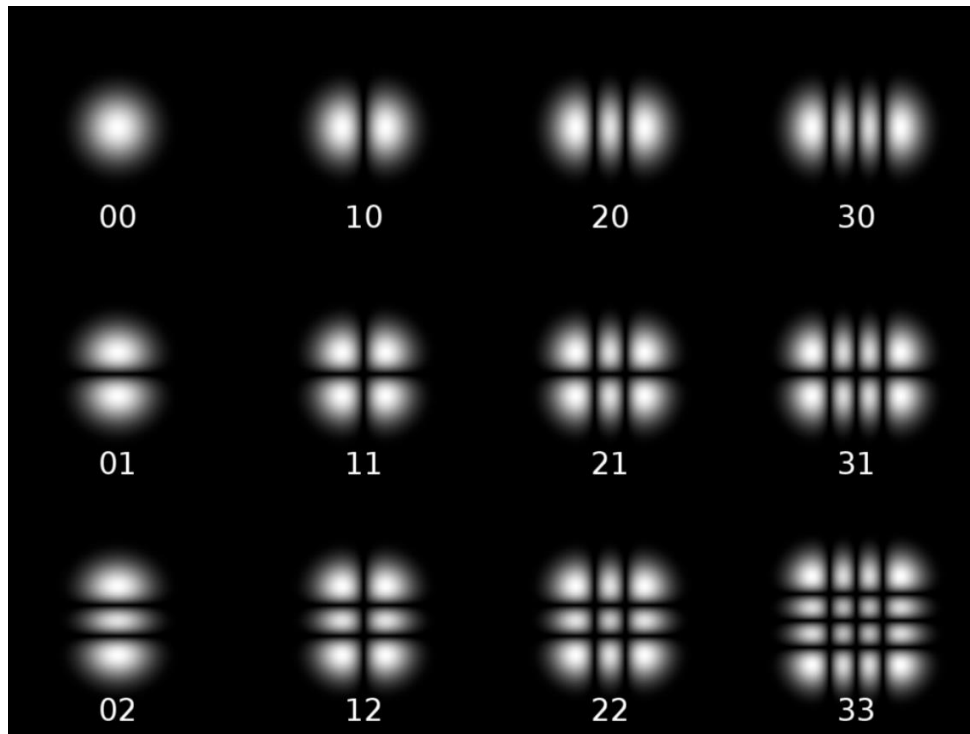

Hermite-Gauss

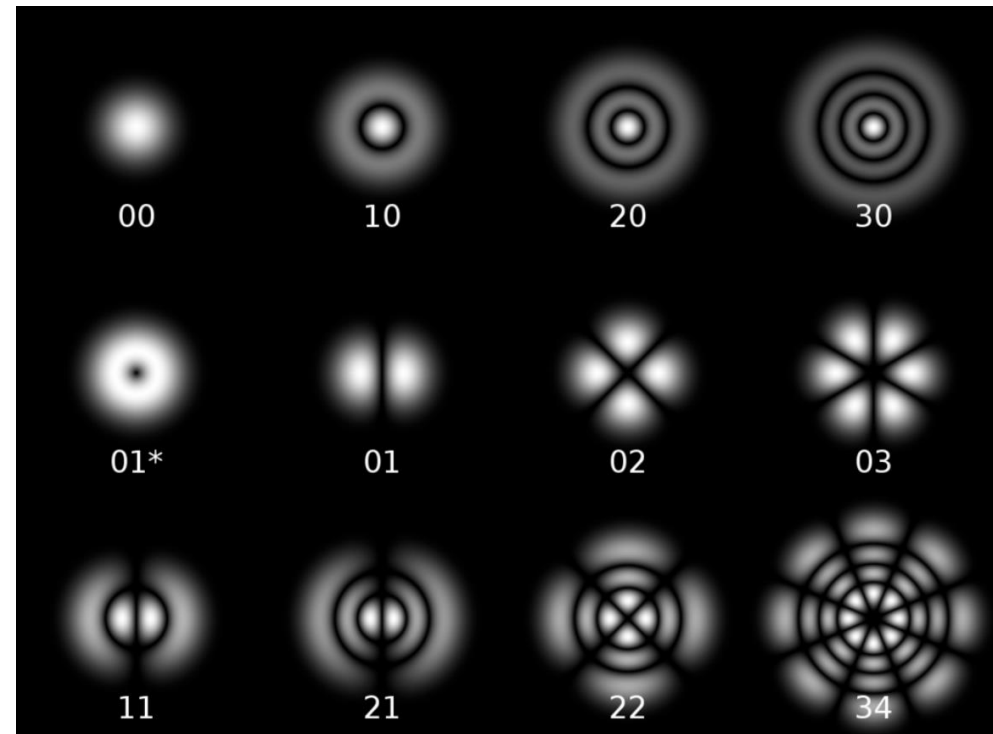

Laguerre-Gauss

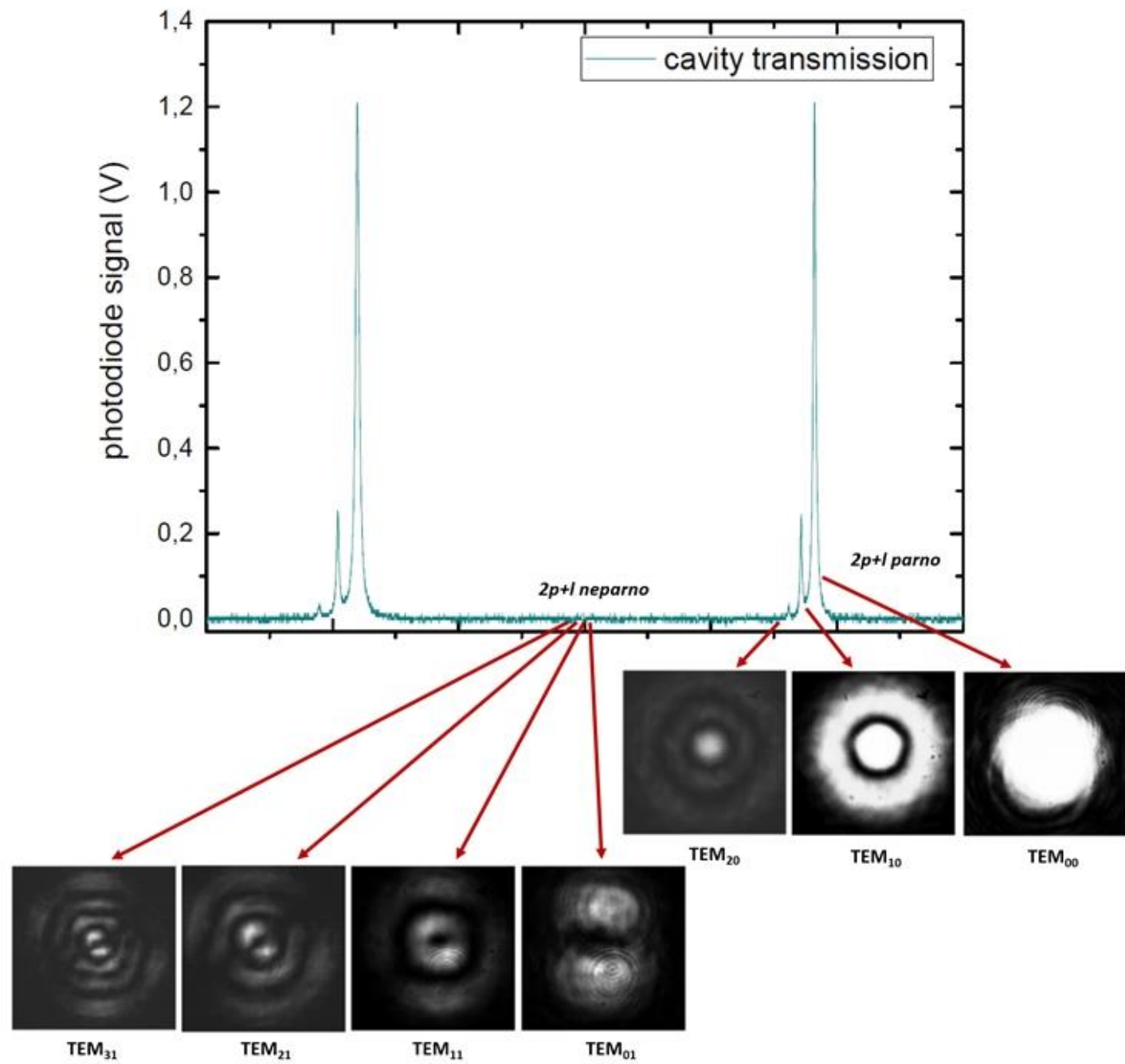

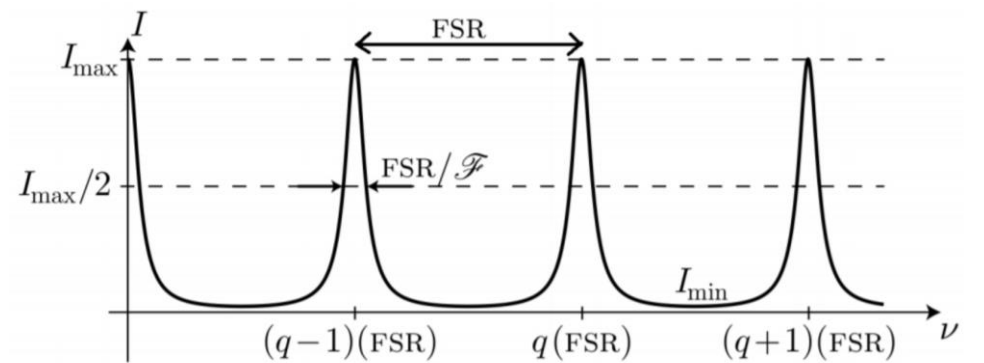
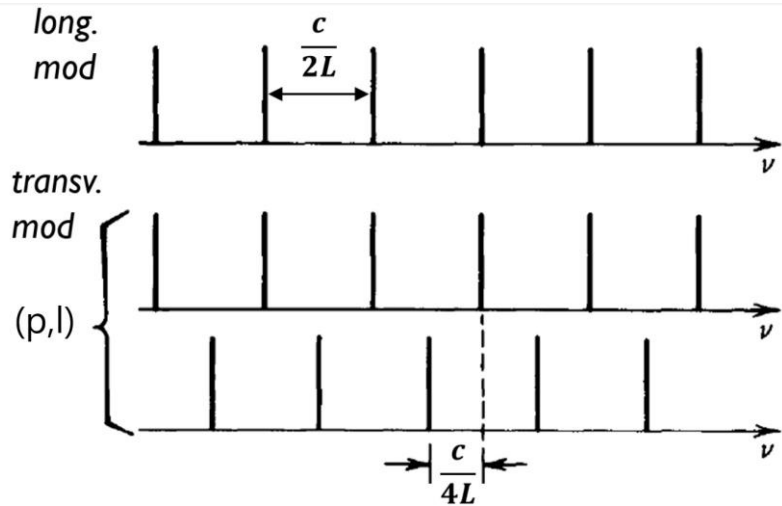
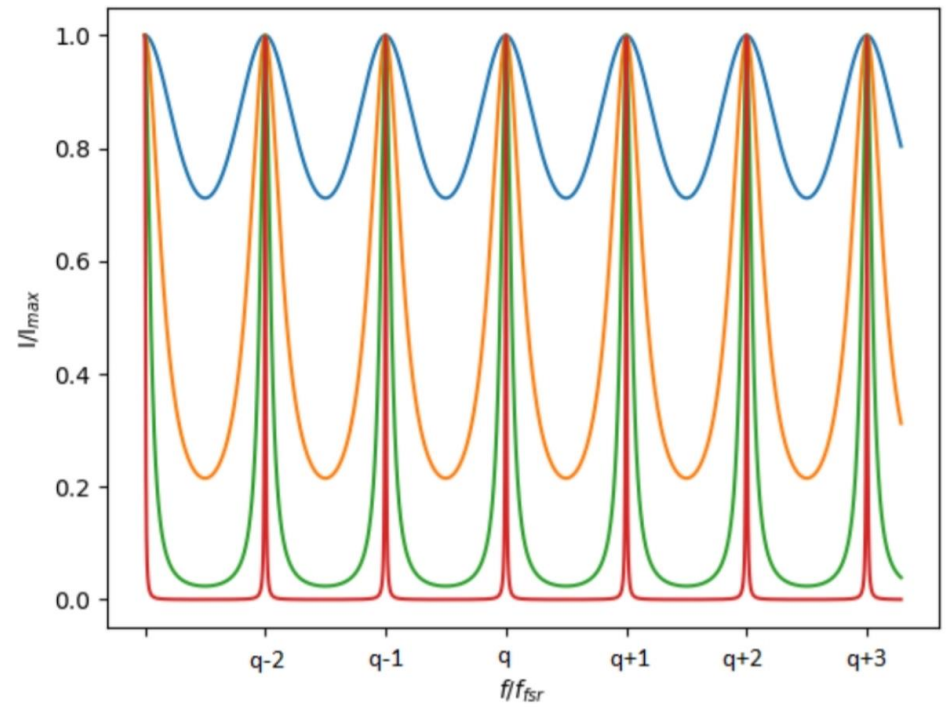
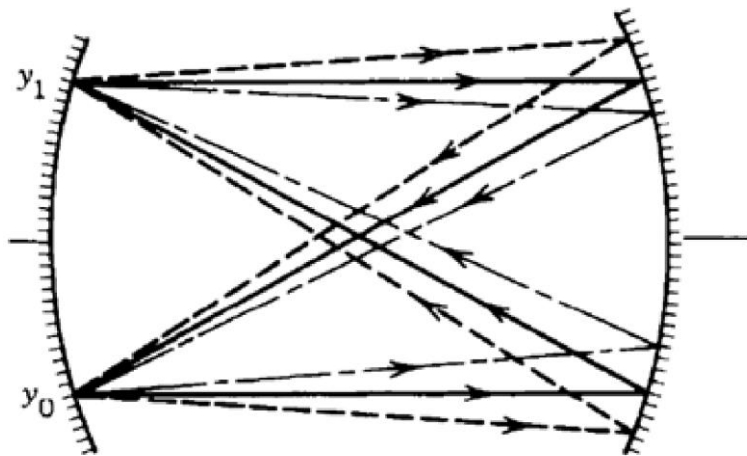

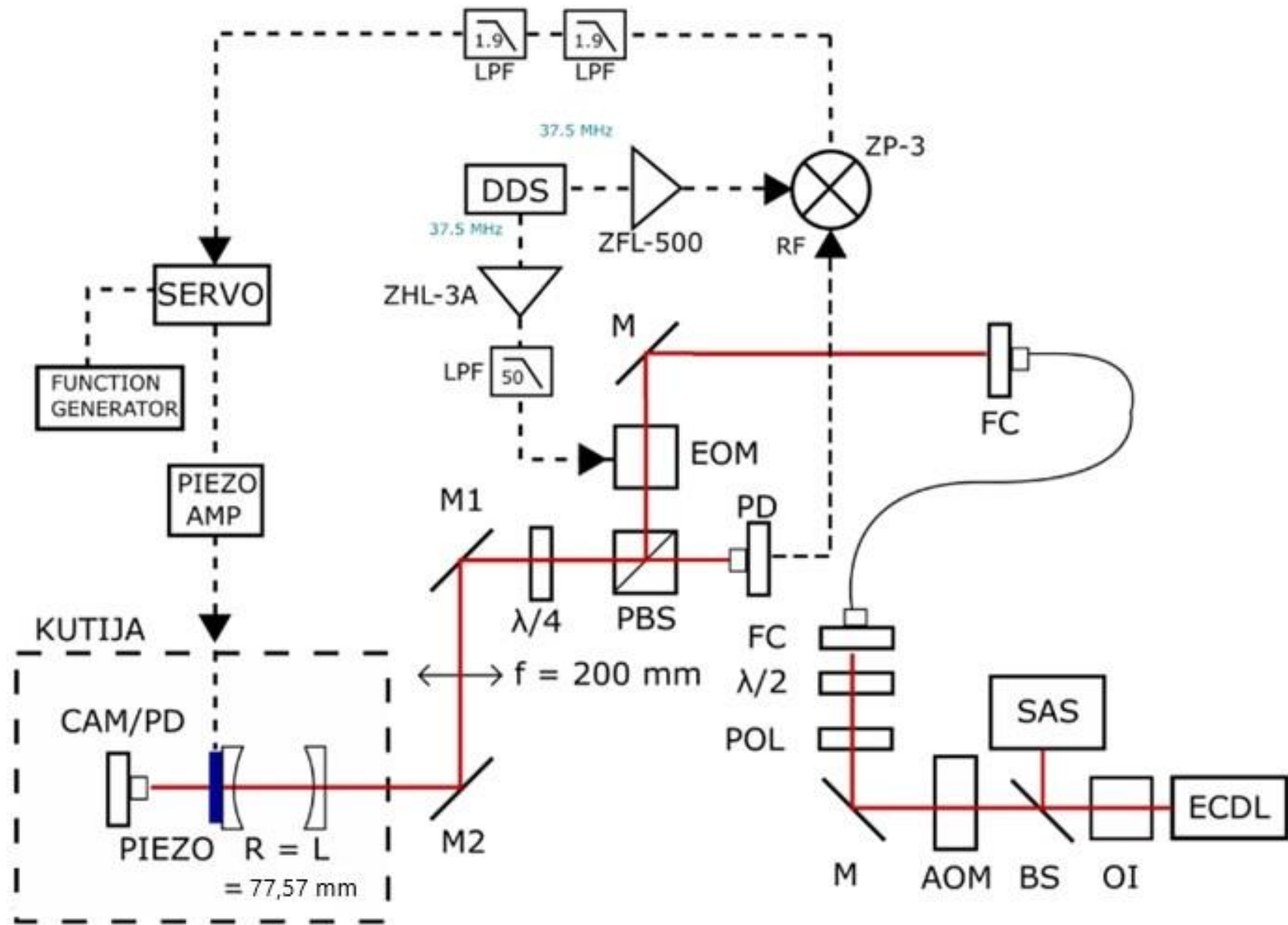

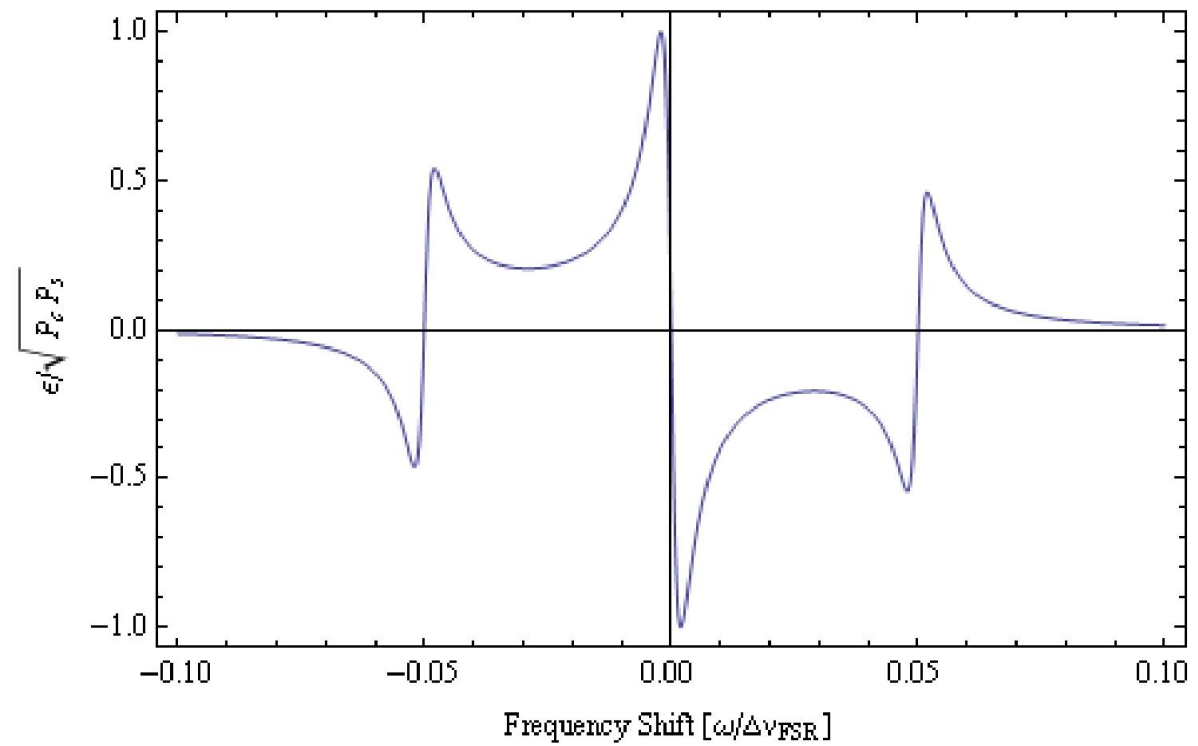
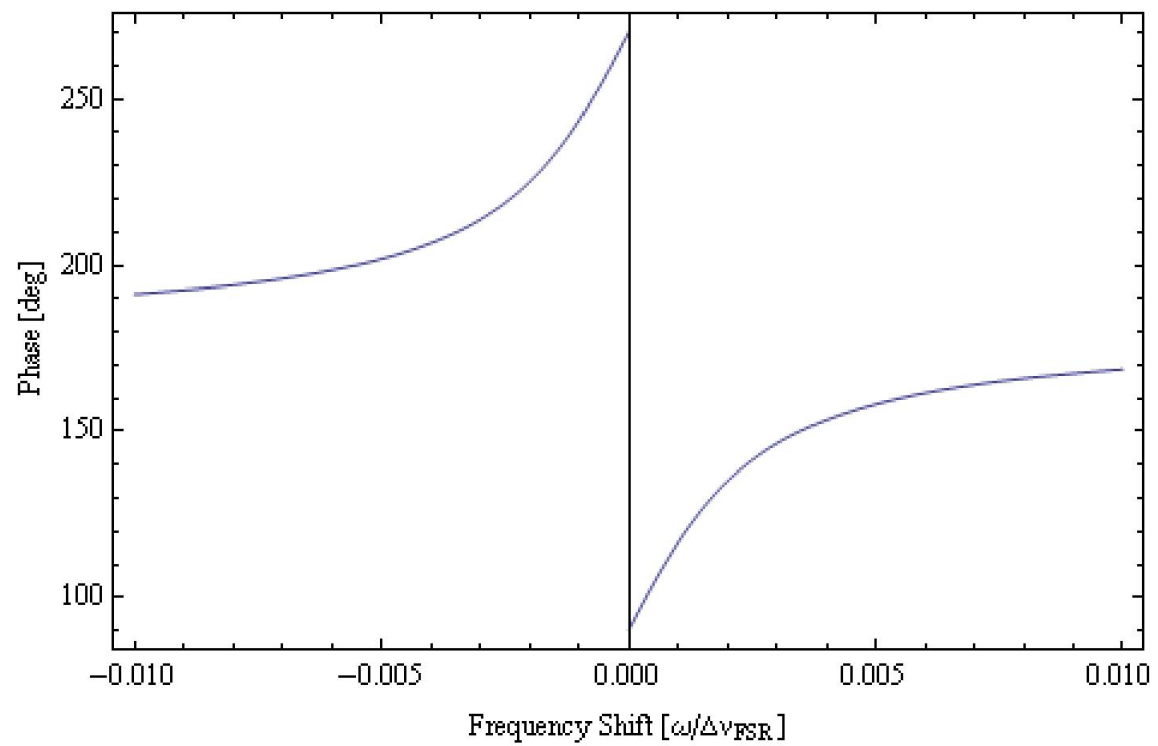



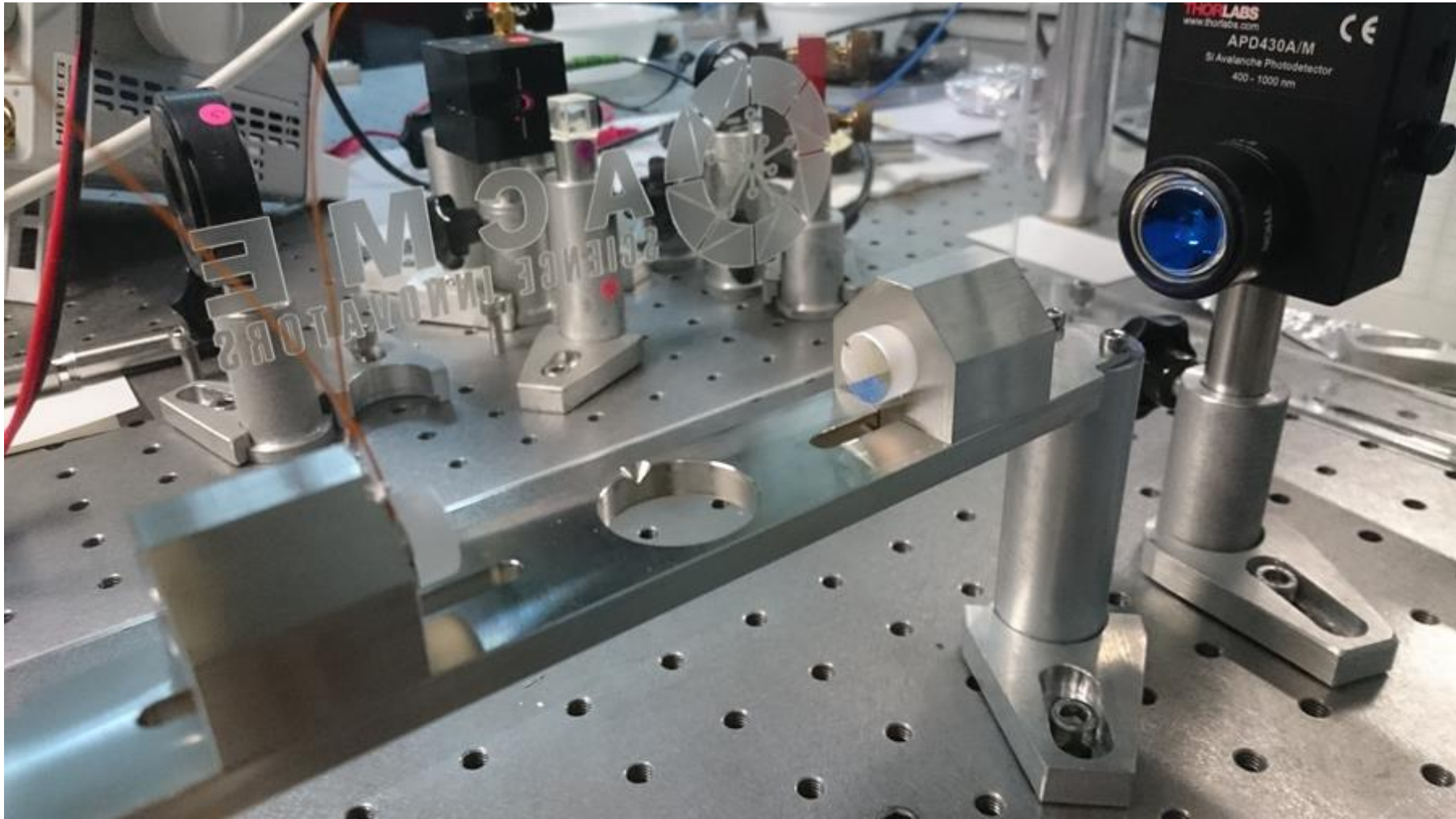

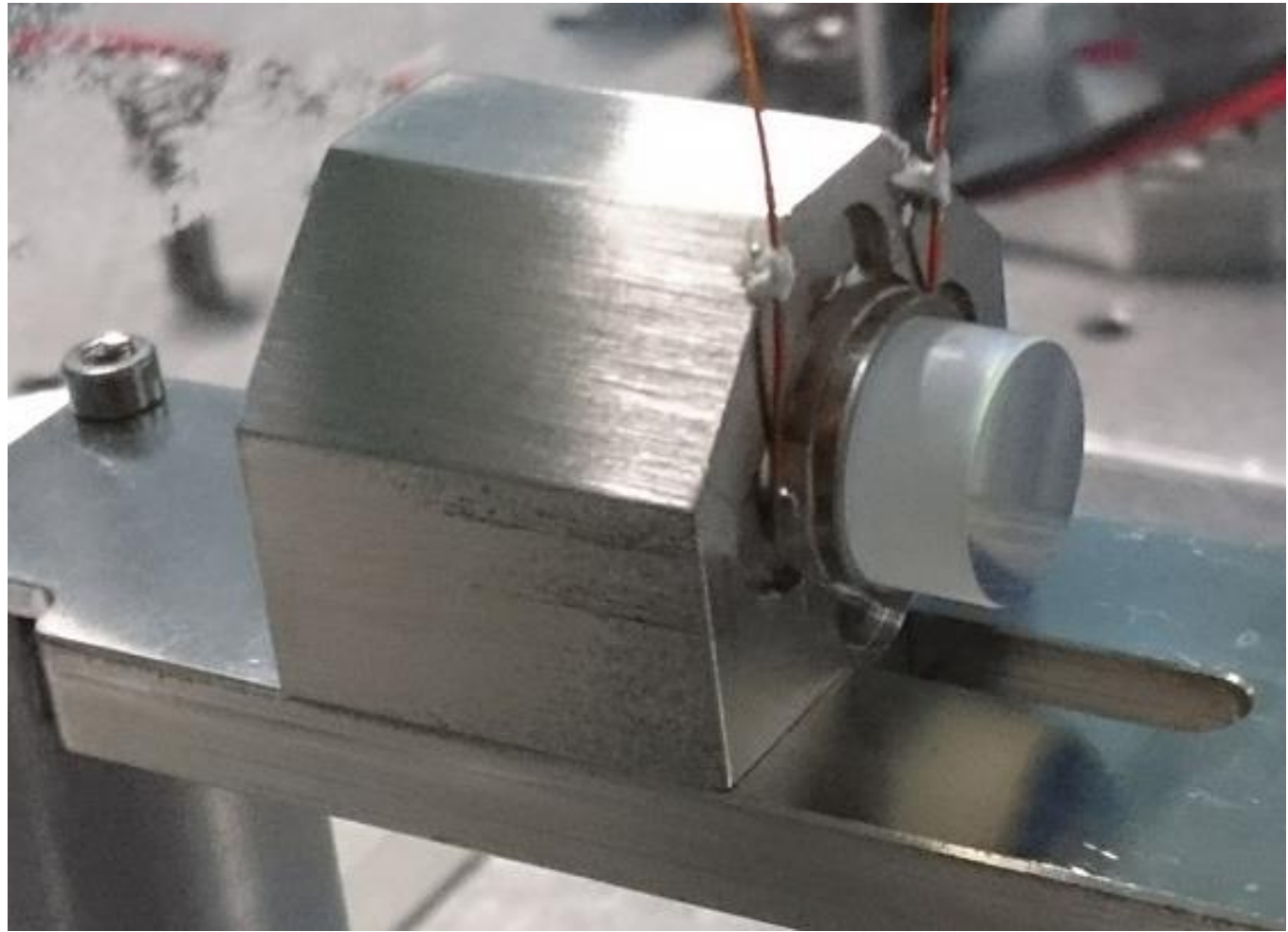

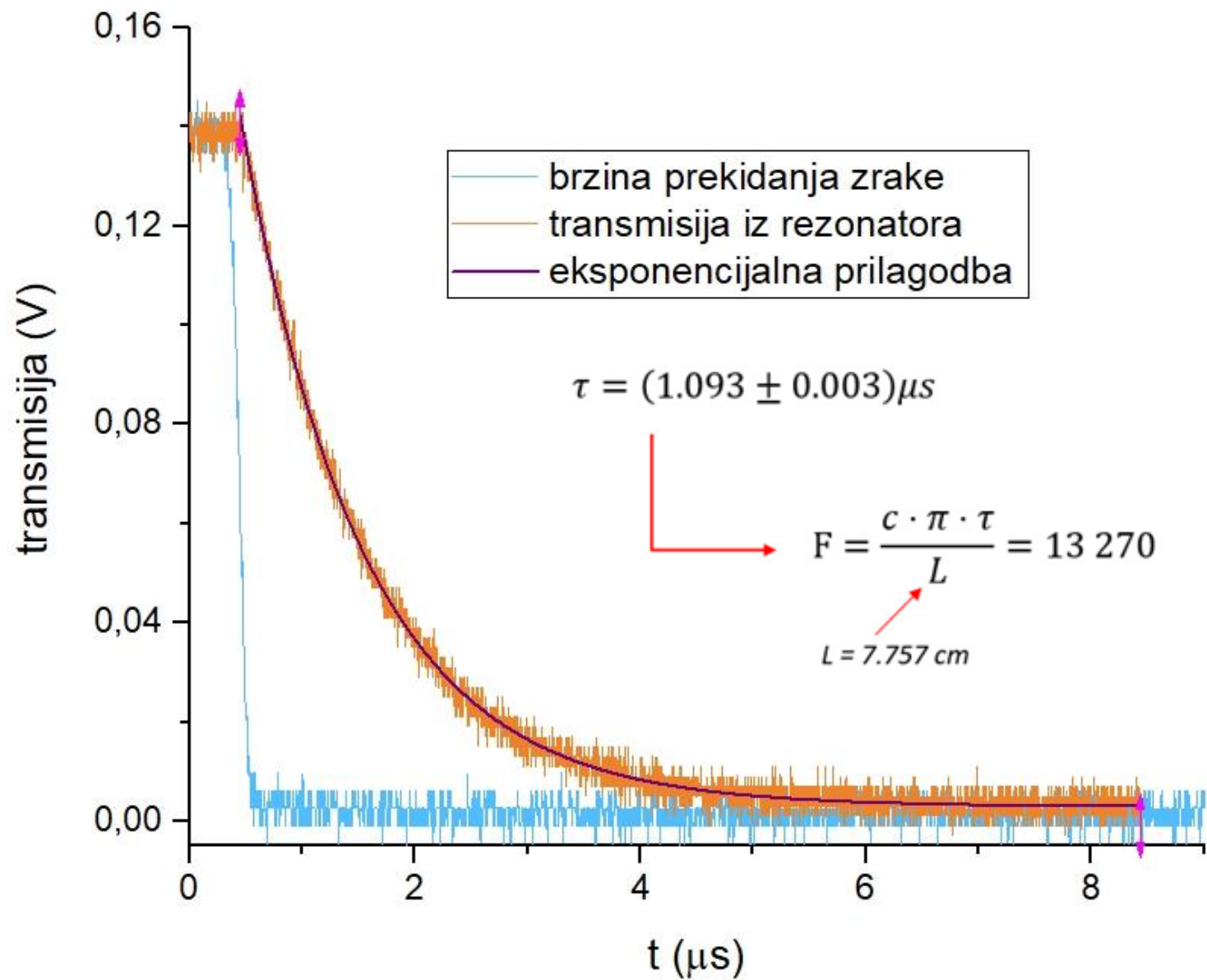

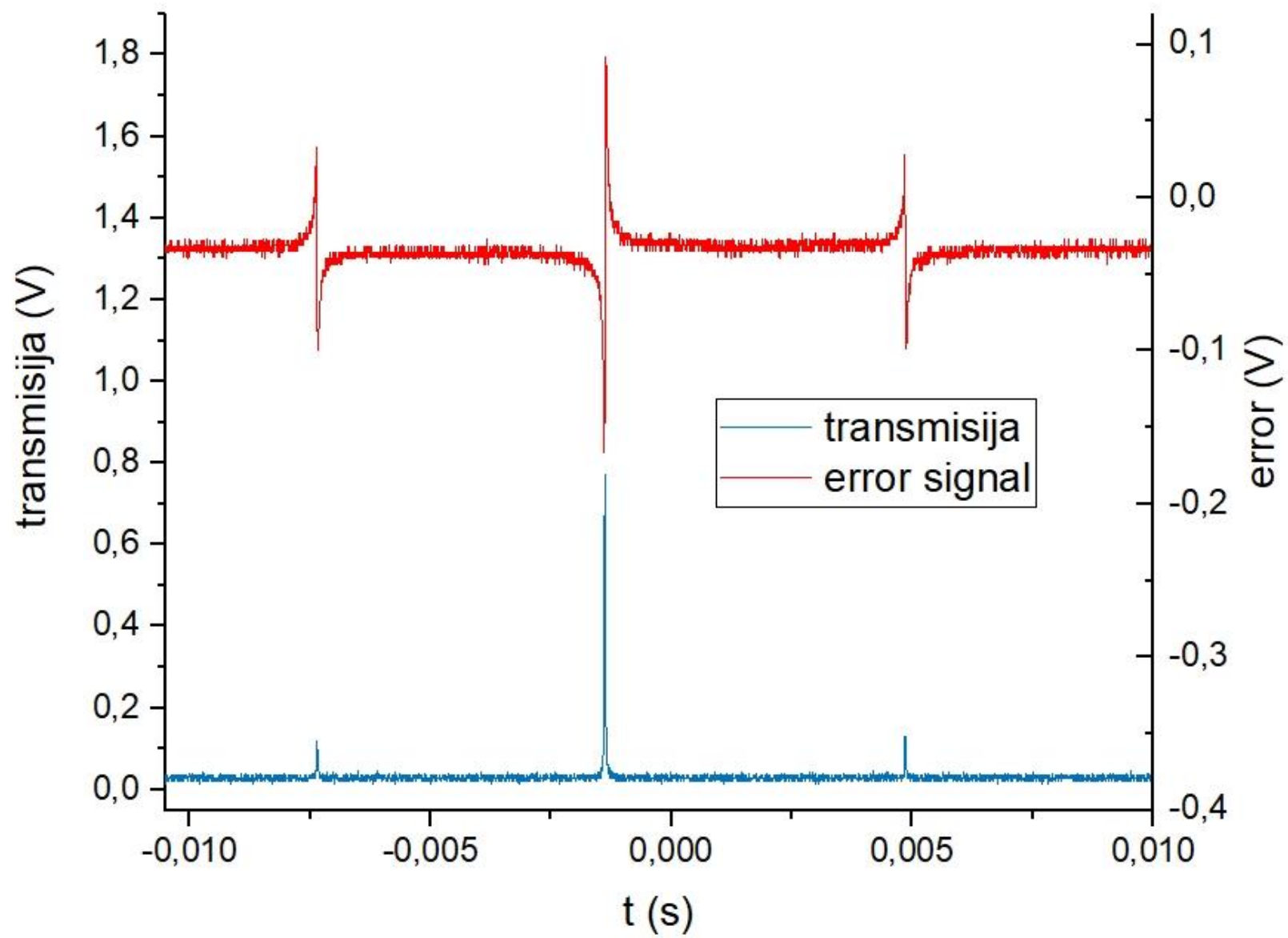

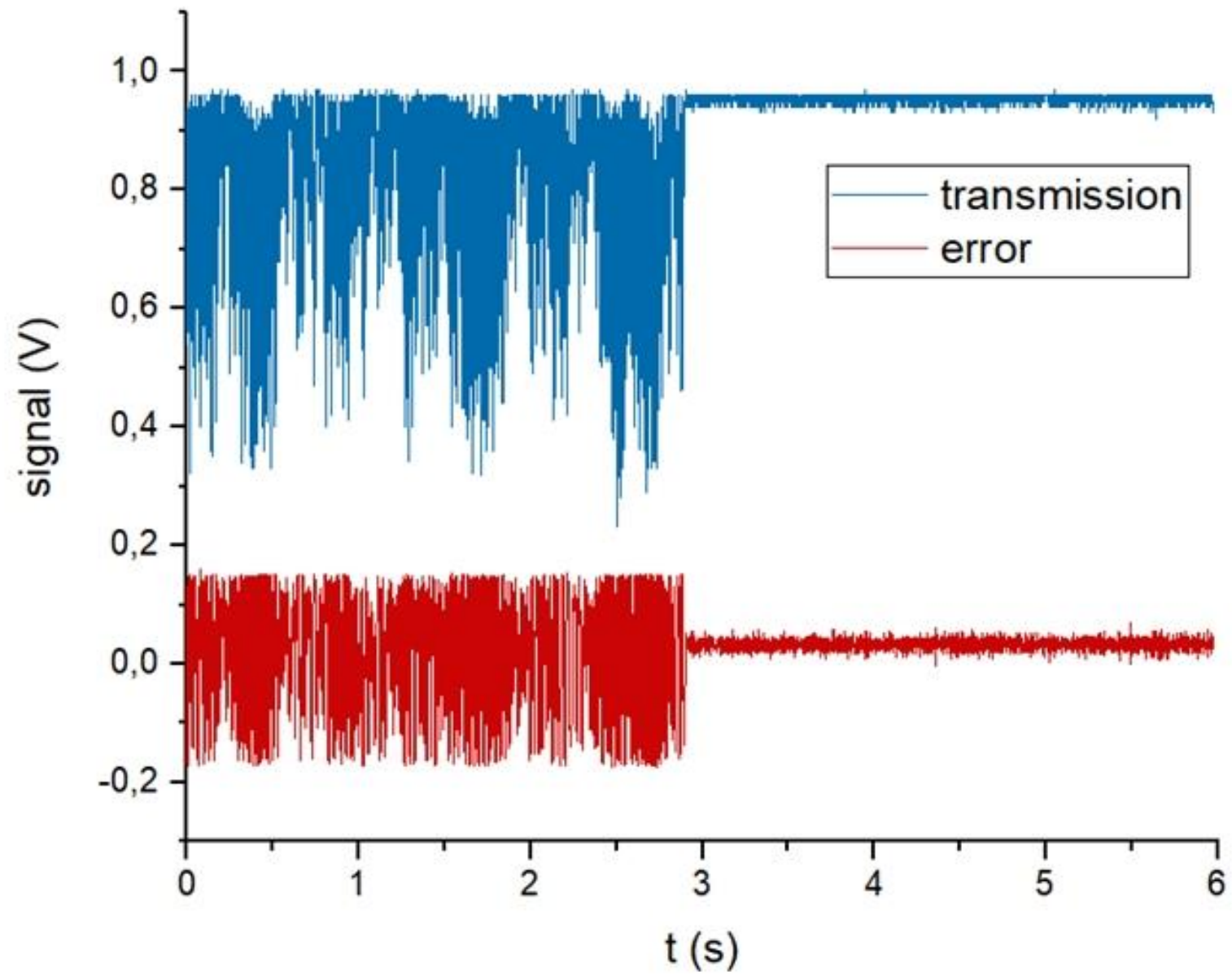



Hvala na pažnji!