

- **Small DNA genome virus cycles**

Bacteriophages with DNA genomes, viruses of mycoplasmas and Archea

Polyomaviridae

Papillomaviridae

Parvoviridae, including genus *Dependovirus*

Geminiviridae

Circoviridae – the smallest viruses in general (17 nm, 1760 bases of cssDNA)

Genome organization is more versatile than in viruses with big DNA genomes!

Polyomaviridae:

- It used to be a subfamily in *Papovaviridae* (papilloma virus/polyoma virus/simian vacuolating virus (SV40)),
- Bird and mammal hosts
- human viruses, mainly asymptomatic, widespread: BKPyV (nephropathy), JCPyV (progressive multifocal leukoencephalopathy (PML) in immunocompromised patients), SV40, new viruses (MCPyV, etc.).

- Genome is circular dsDNA , about 5kbp as a minichromosome in isometric virion of 45 nm (25 nucleosomes in SV40), θ – replication of the genome in nucleus, virion assembly too. Infection is lytic.

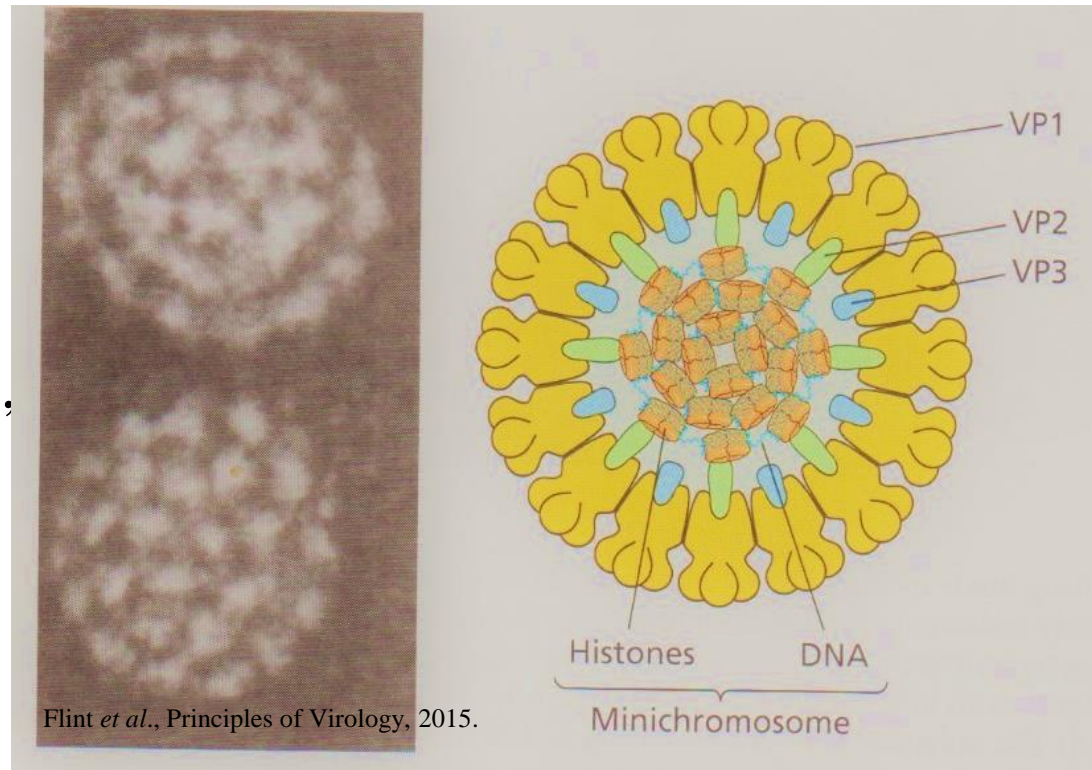

Temporally regulated transcription – early and late genes.

Ori – regulatory region between early and late, origin of DNA replication, strong enhancers, strong SV40-promoters (the basis for commercial expression vectors).

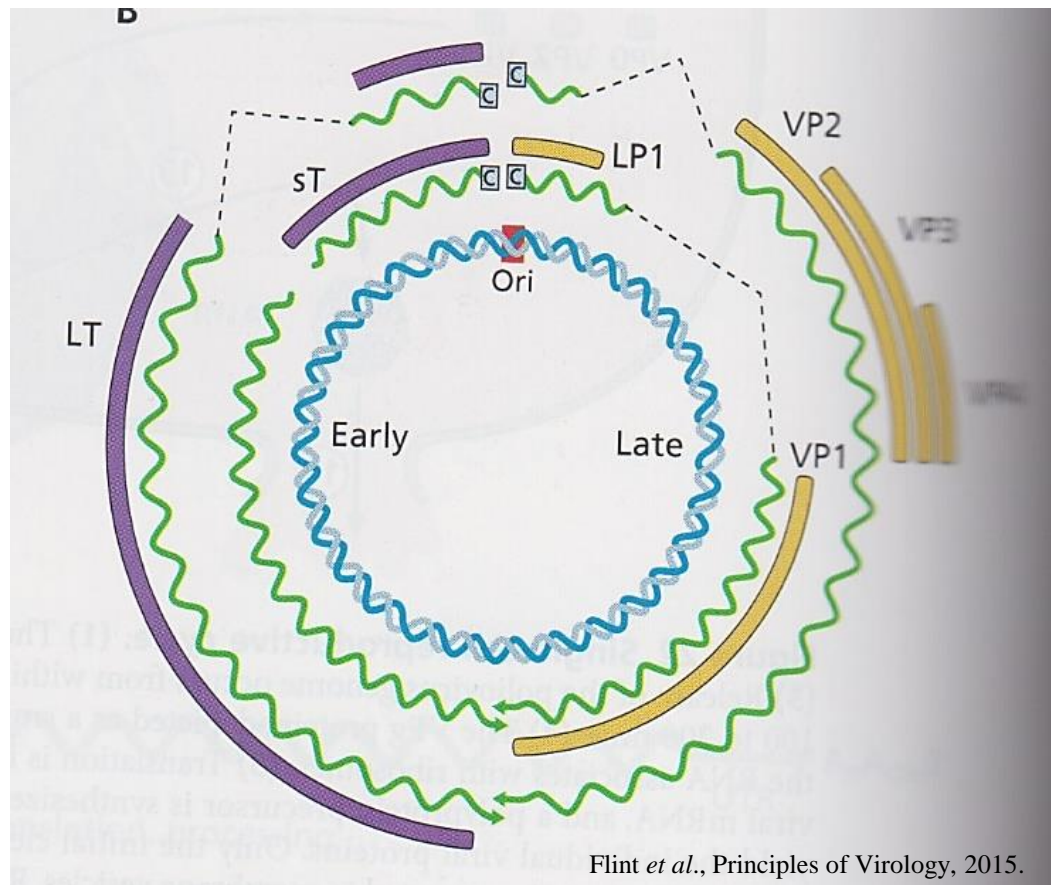

Linearized transcriptome of SV40 (5243 bp)

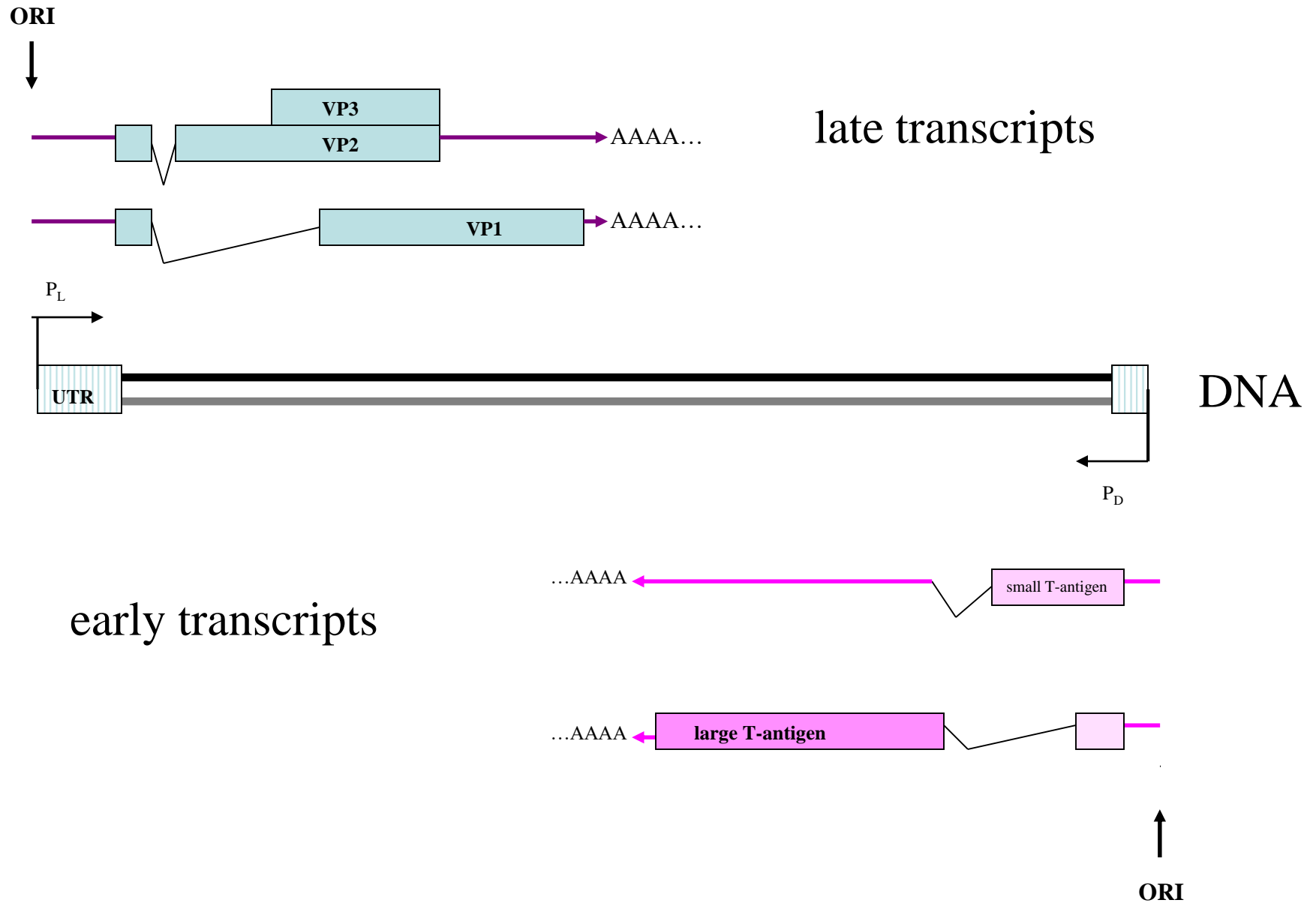

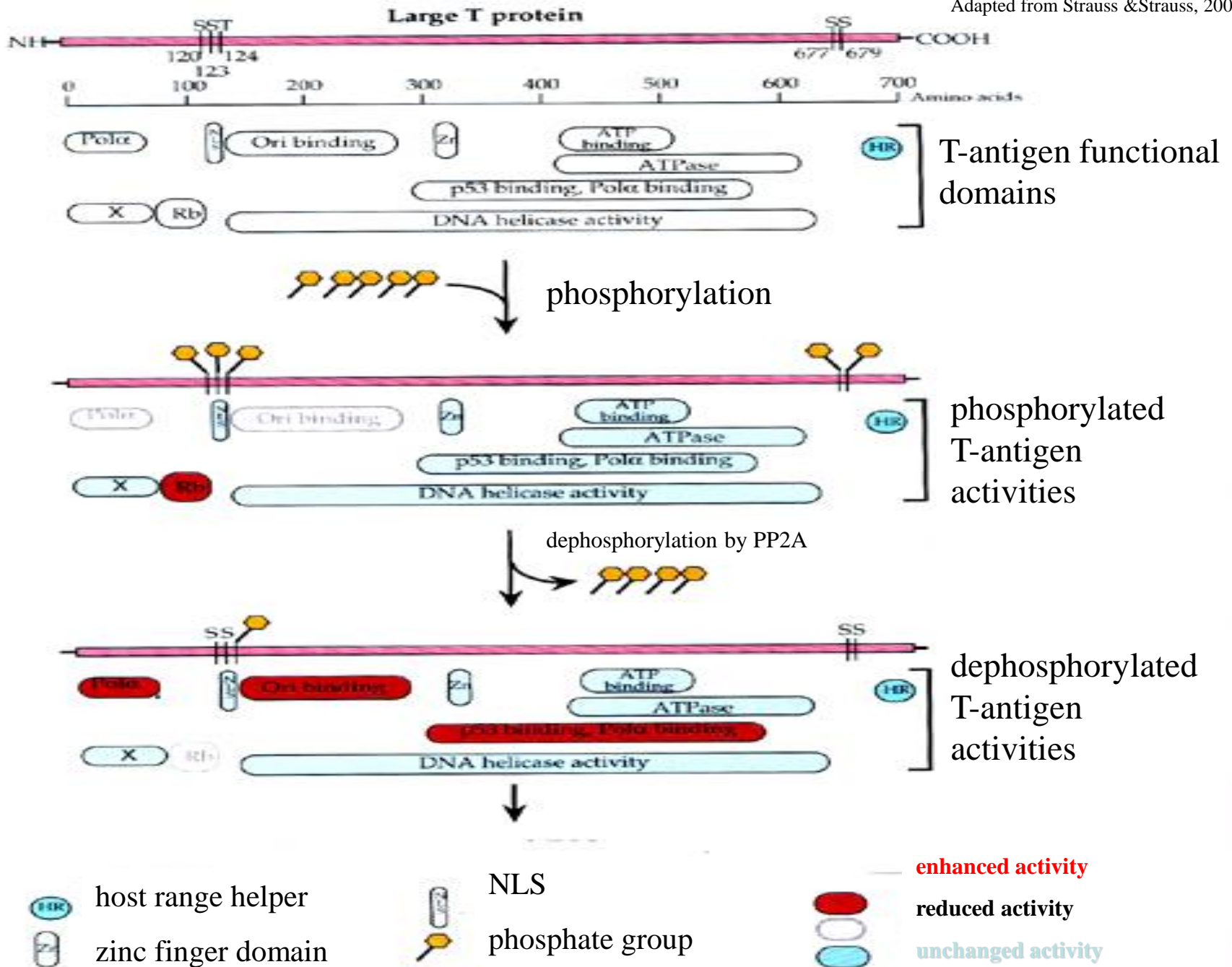

T is tumor antigen. Its expression, even without productive infection, transforms the cell and leads into tumor formation in animals.

The simplest example in SV40, but there are T antigens of different sizes.

Multifunctional protein – interaction with viral promoters and cell proteins.

Differentially regulated by Ser and Thr aa-residue phosphorylation.

Large T-antigen binds p53 and Rb (tumor suppressor proteins).

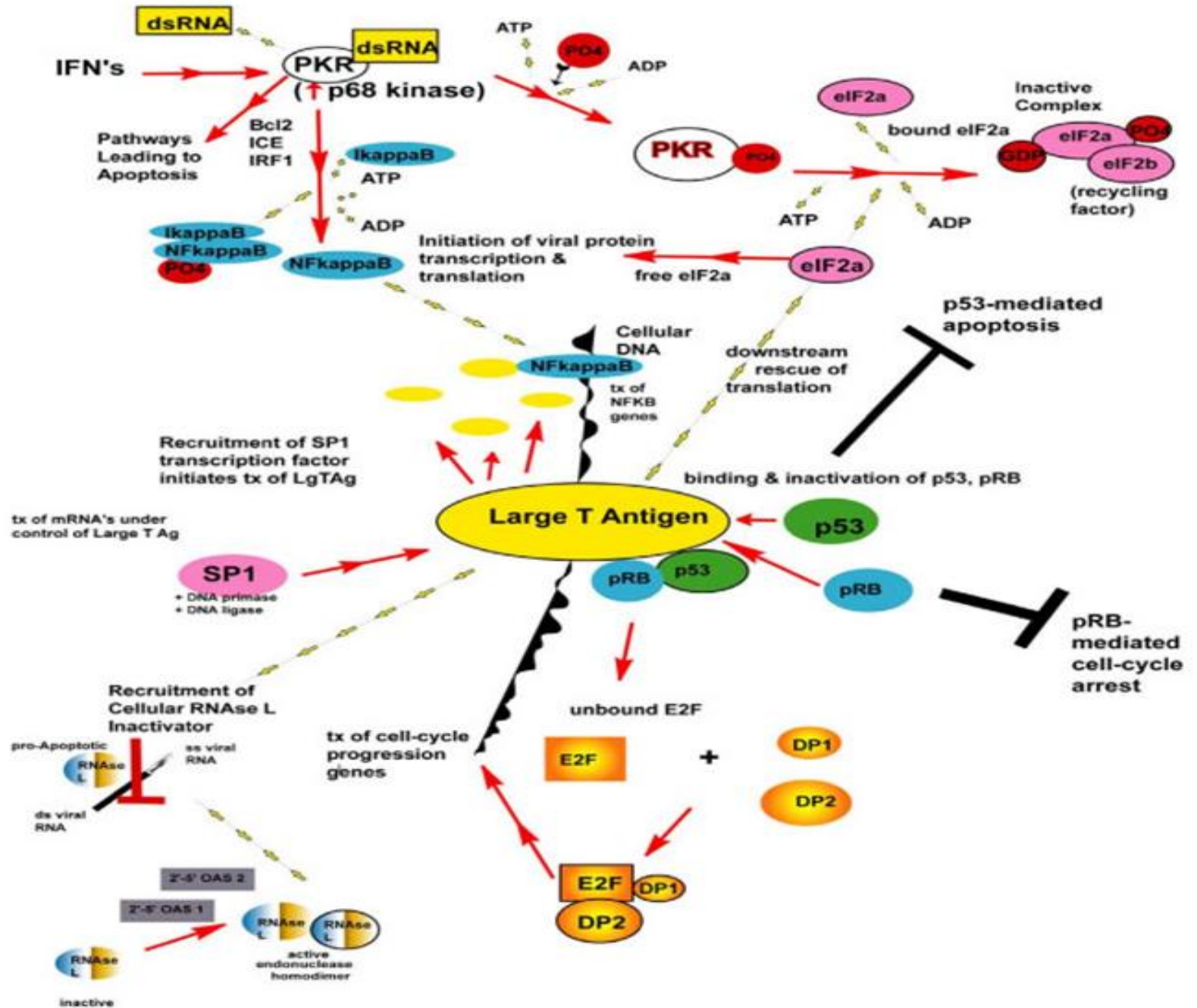

Papillomaviridae:

Structurally similar to polyomaviruses,

somewhat bigger (55nm, cdsDNA 8 kbp),

primarily infect mammals, some found in birds,

host specificity limited to the species level.

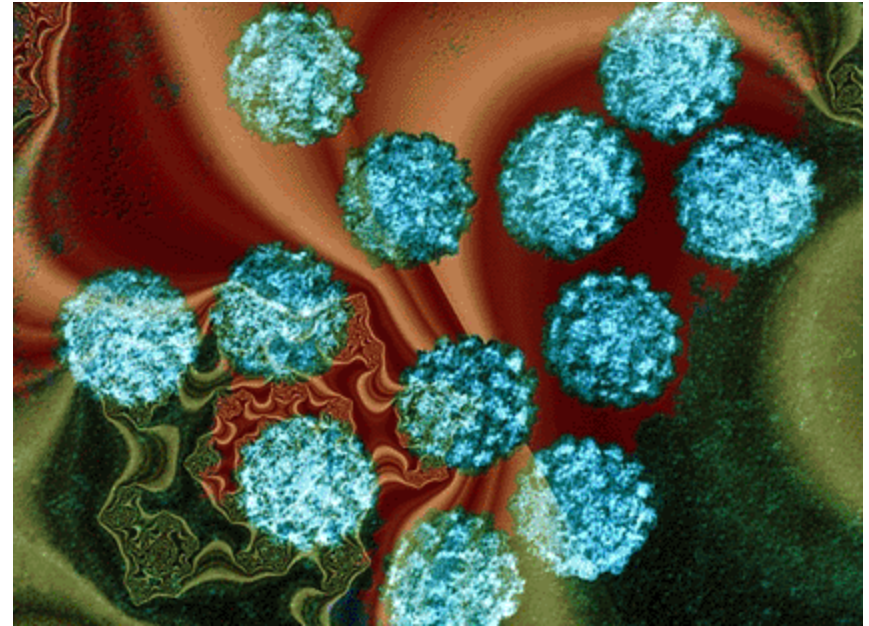

Dr. Linda Stannard, UCT-SPL

Complete cycle only in terminally differentiated cells,
most often in epithelia – cultivation difficulties

They induce cell proliferation – warts (papilloma), occasionally tumors.

HPV (*Human papilloma virus*)

All genes are transcribed from one DNA chain! Some genes overlap, alternative splicing, posttranslational processing.

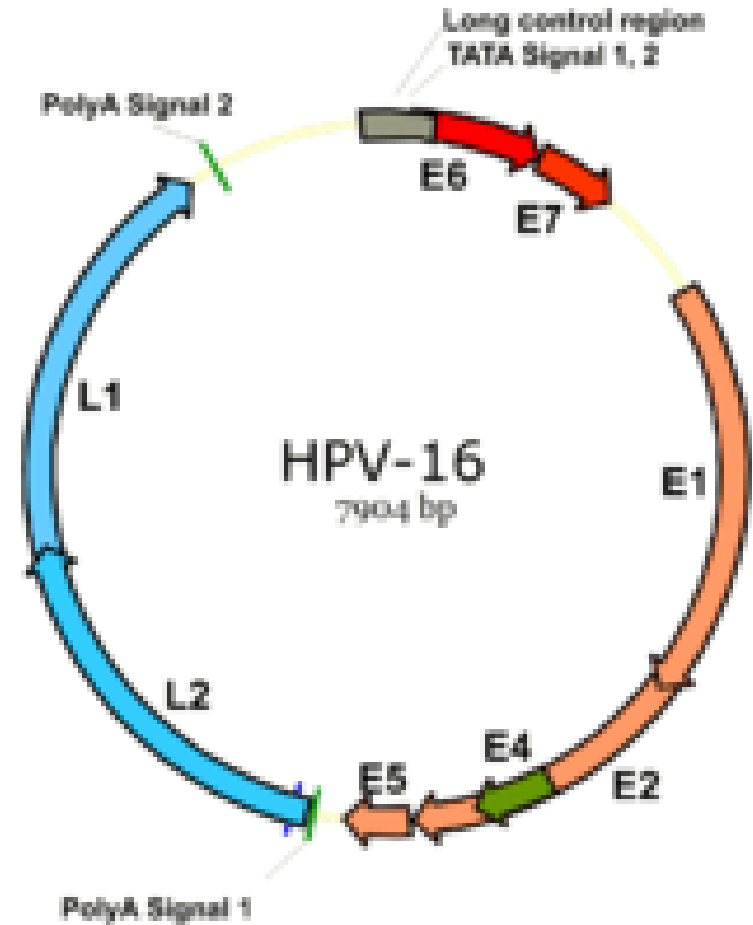
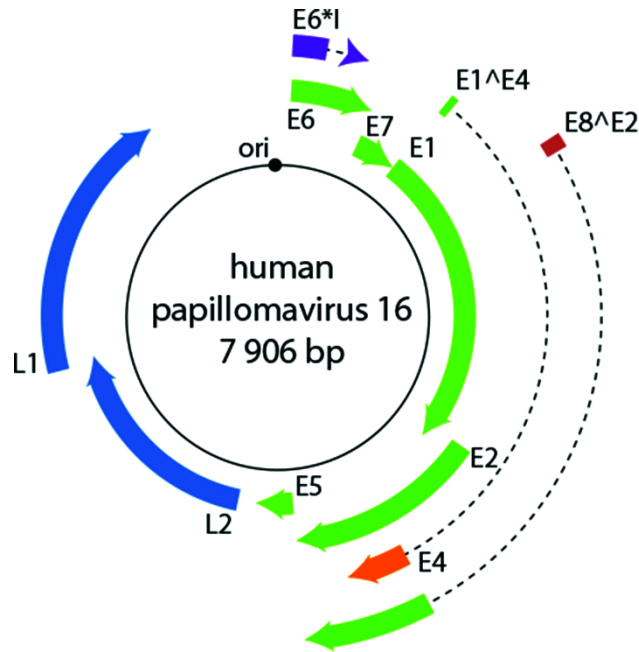

In cells with unproductive cycle, virus exists as an episome (number of episome copies 50-400).

E6 binds p53 and E7 binds Rb – the basis of oncogenicity.

HPV – about 100 types of which 30-40 infects genital mucosa.

HPV-16 and -18 high risk types (found in 70% of women with cervical cancer). HPV-16 can integrate in the cellular DNA.

In 99% cervical cancer cases, some high risk HPV-type was found.

PAPA – test (*PAP smear*)

It allows identification of abnormal cells.

Precancerous cells – transformation potential.

Lesions – clusters of precancerous cells.

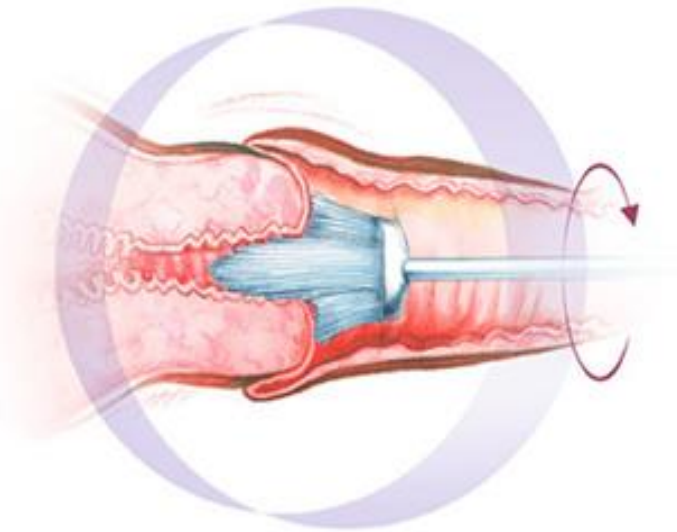

New HPV test types – include screening tests based on the viral DNA analyses.

CIN (*Cervical Intraepithelial Neoplasia*)

CIN 1 - spontaneous recovery expected, more than 50% of women with CIN1 do not need treatment.

CIN 2 – higher probability of transformation. Treatment – part of the cervix removed to prevent the disease.

CIN 3 - surgical treatment is always needed in this case.

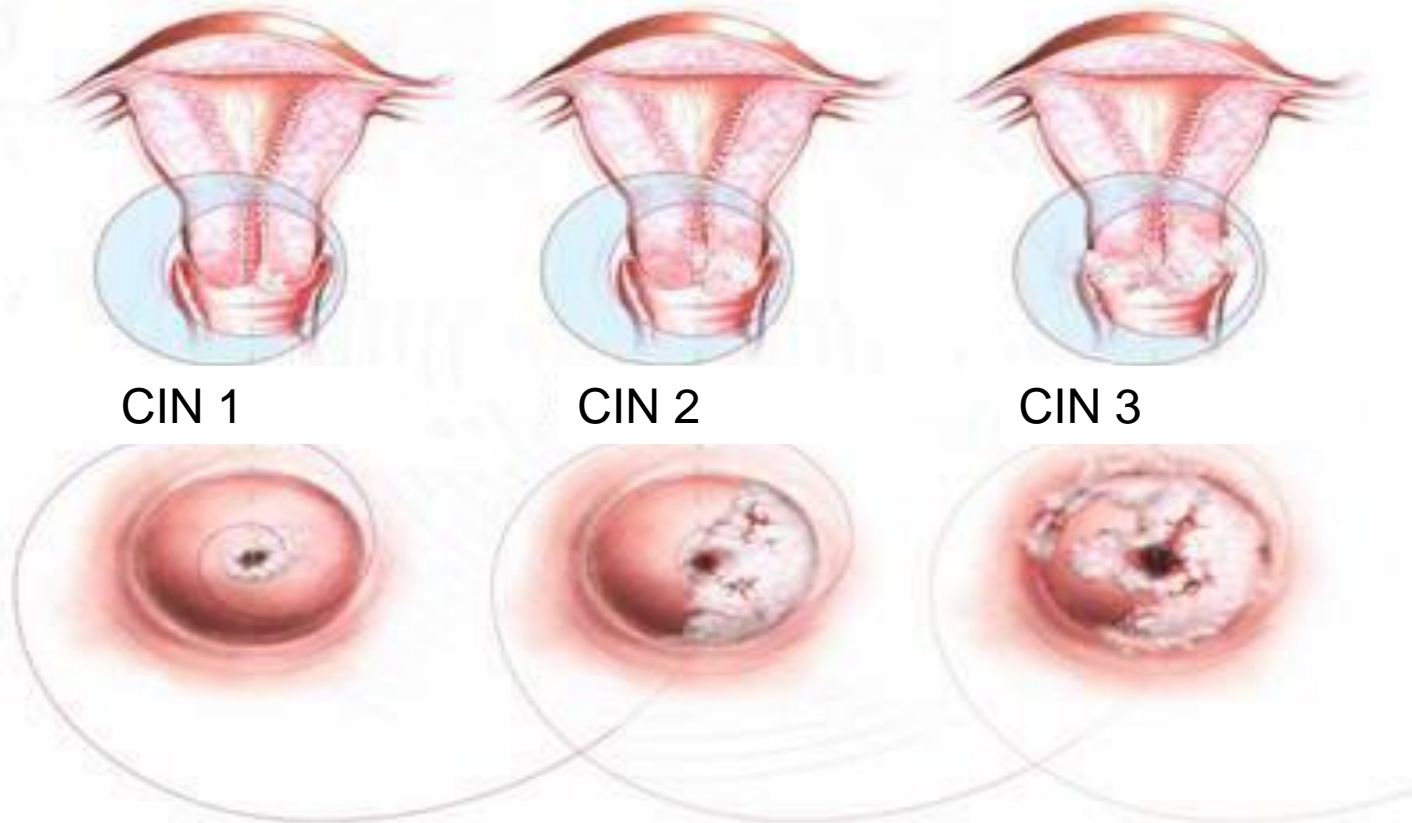

Human papillomavirus phylogeny- N-terminal part of E2

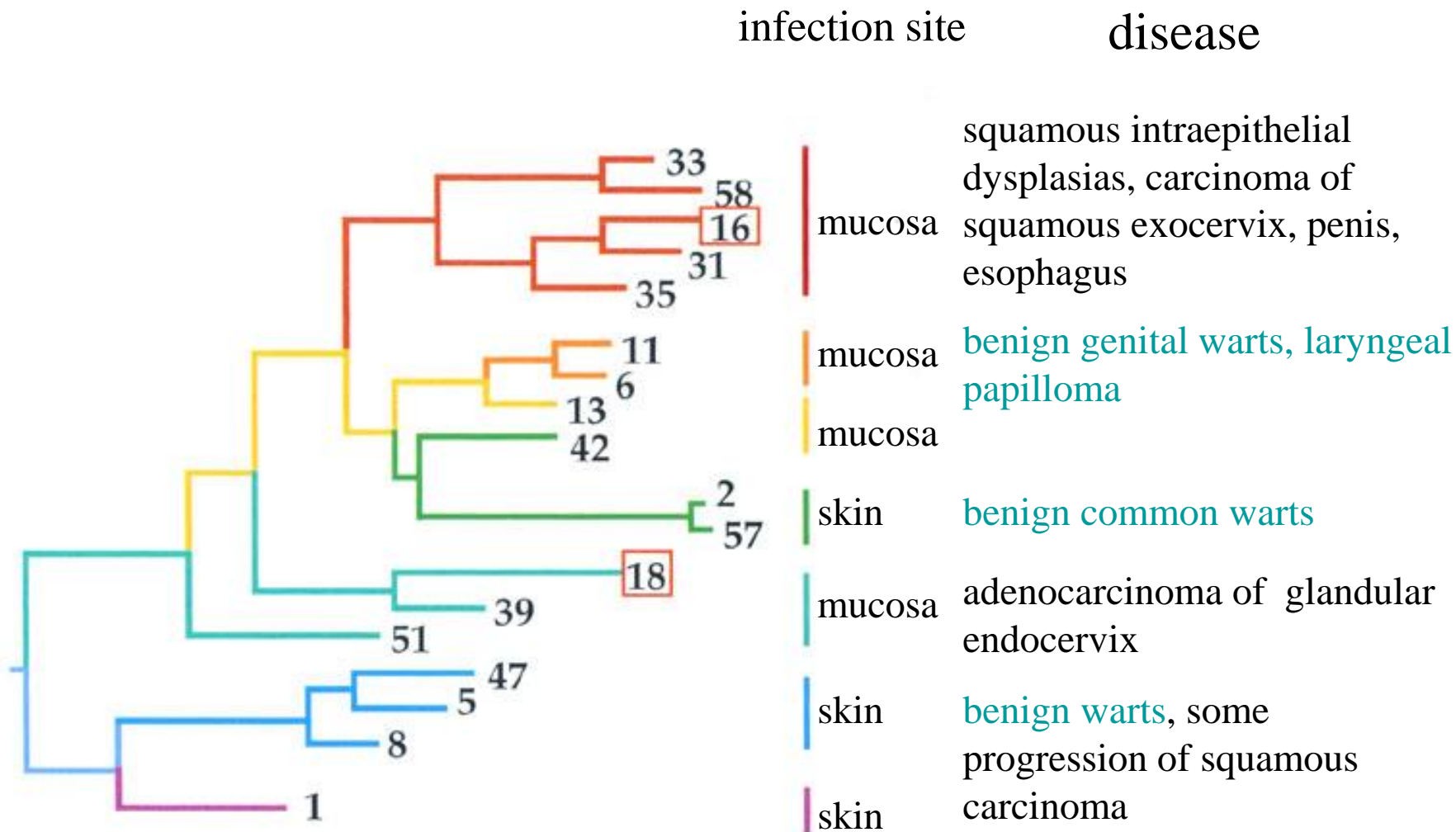

Strauss & Strauss, 2002

HPV vaccines – protection from HPV-16, -18, -31, -45.

Parvoviridae:

- small (lat. *parvus*) isometric 18-26 nm, ssDNA, 4-6 kb, few genes, complicated splicing
- viruses of mammals, birds, insects (*Bombyx mori*)
- *Primate erythroparvovirus 1* (B19V) – infects erythrocyte precursors (*erythema infectiosum* = *fifth disease*), arthritis in adults
- replicate only in dividing cells
- (pseudo)satellitism - genus *Dependovirus*

Parvovirus genome

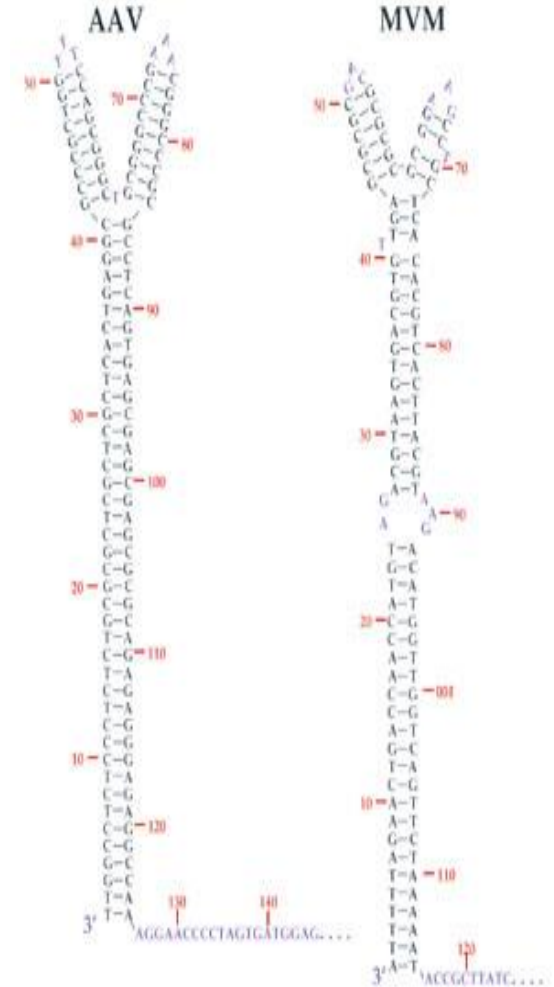
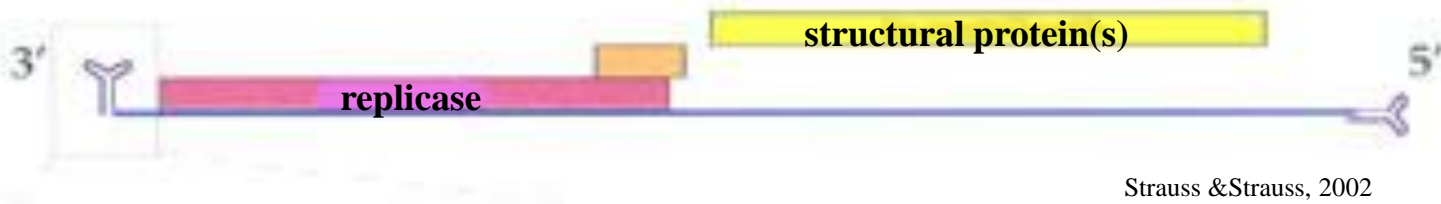

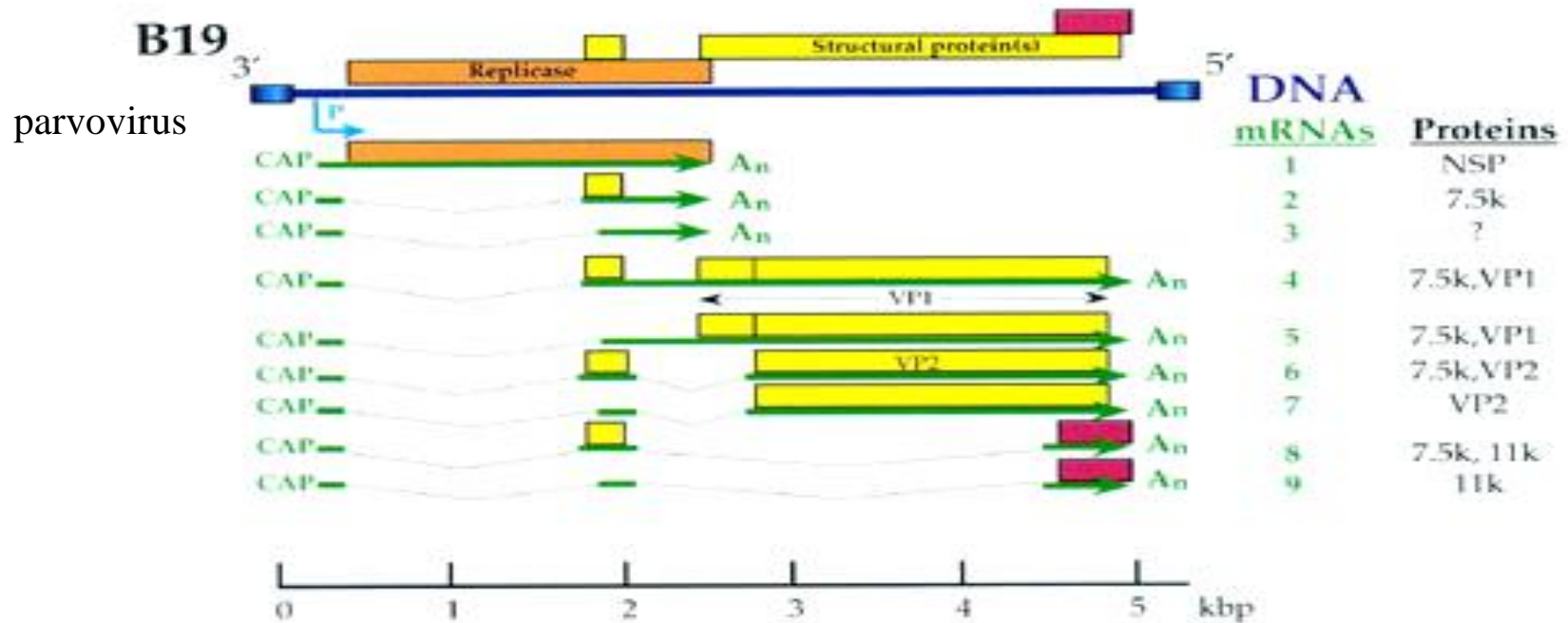
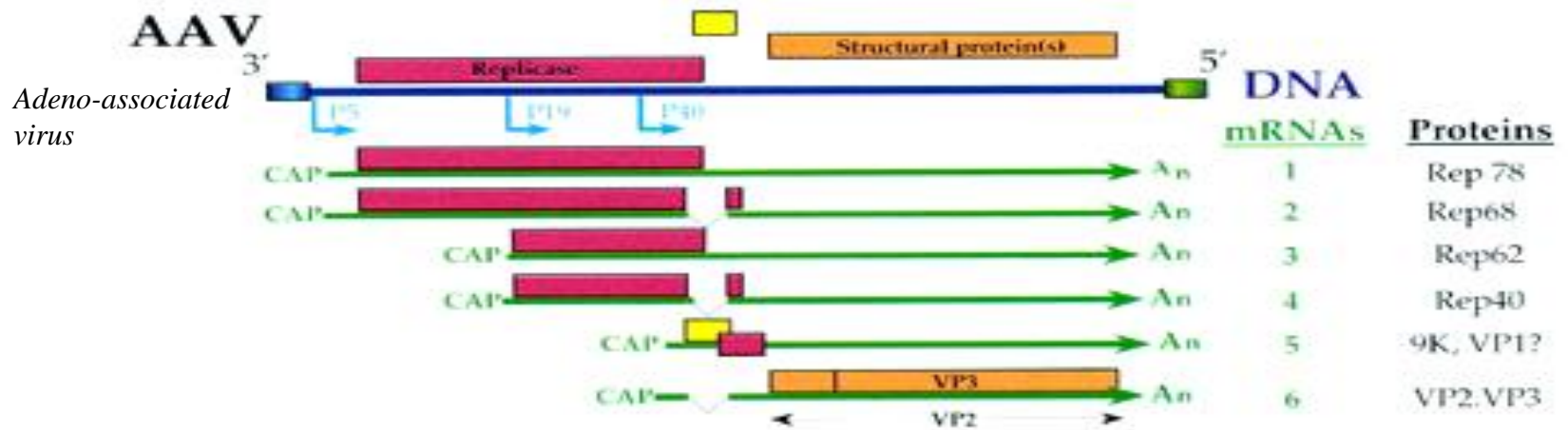

Genome replication in parvoviruses – “rolling hairpin” model

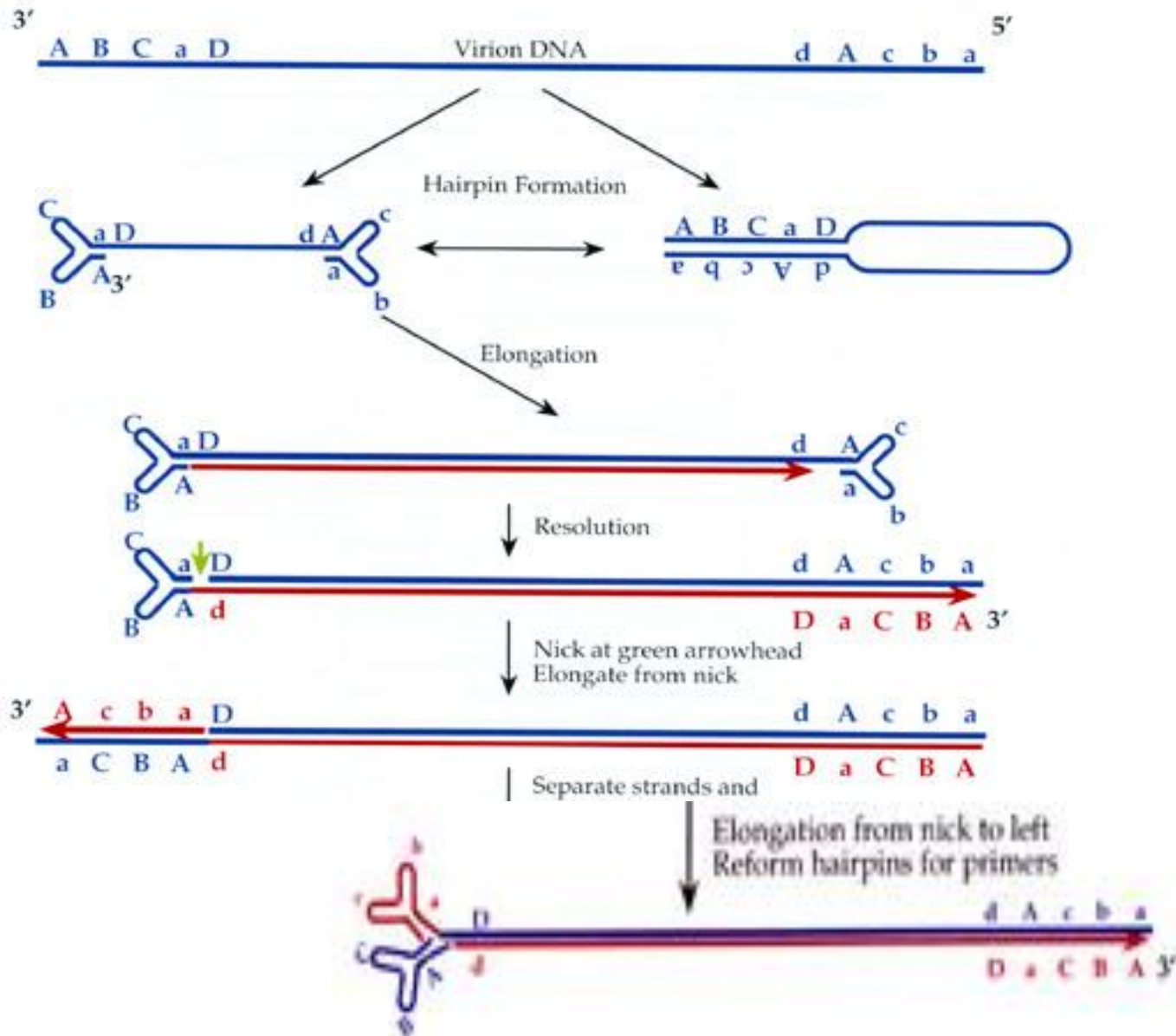

Parvoviral cycle

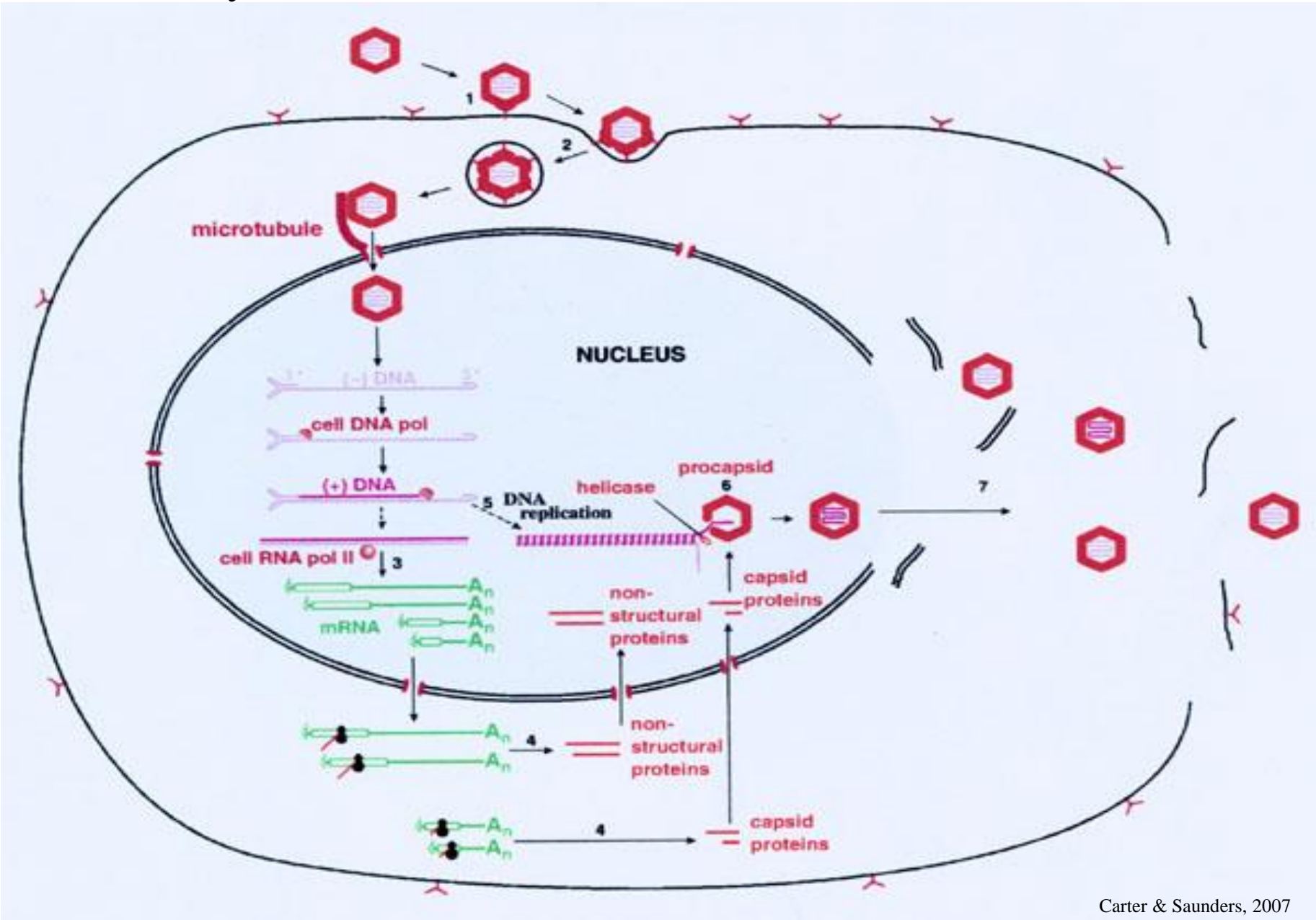

Dependovirus cycle

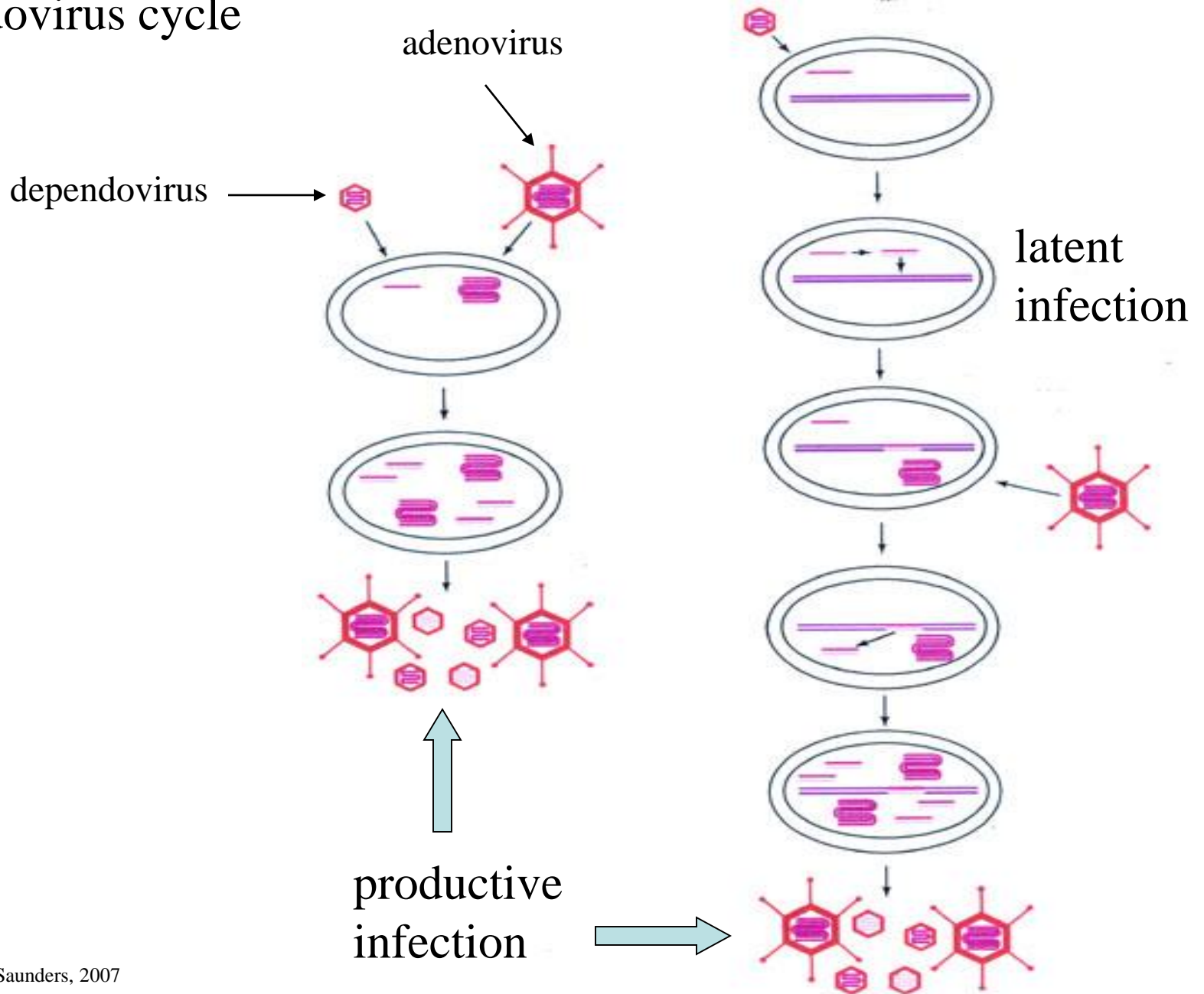

Geminivirus – plant viruses, economically important, satellite DNA!

Bipartite (some), ssc+DNA (arbitrary +).

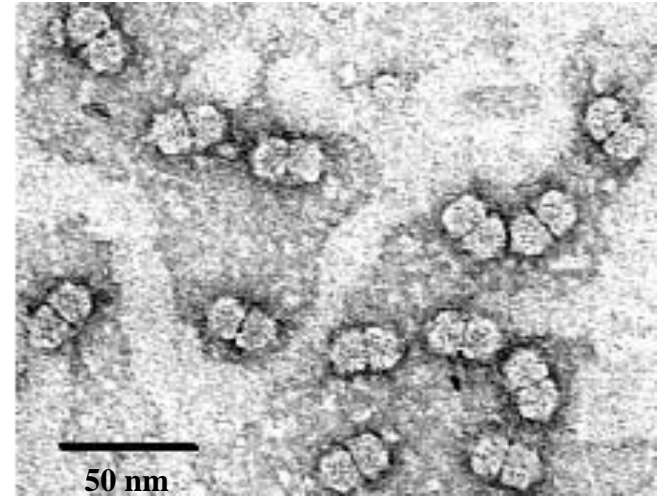
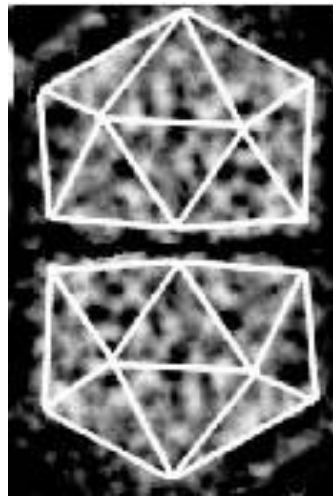

Maize streak Geminivirus, 18x30 nm

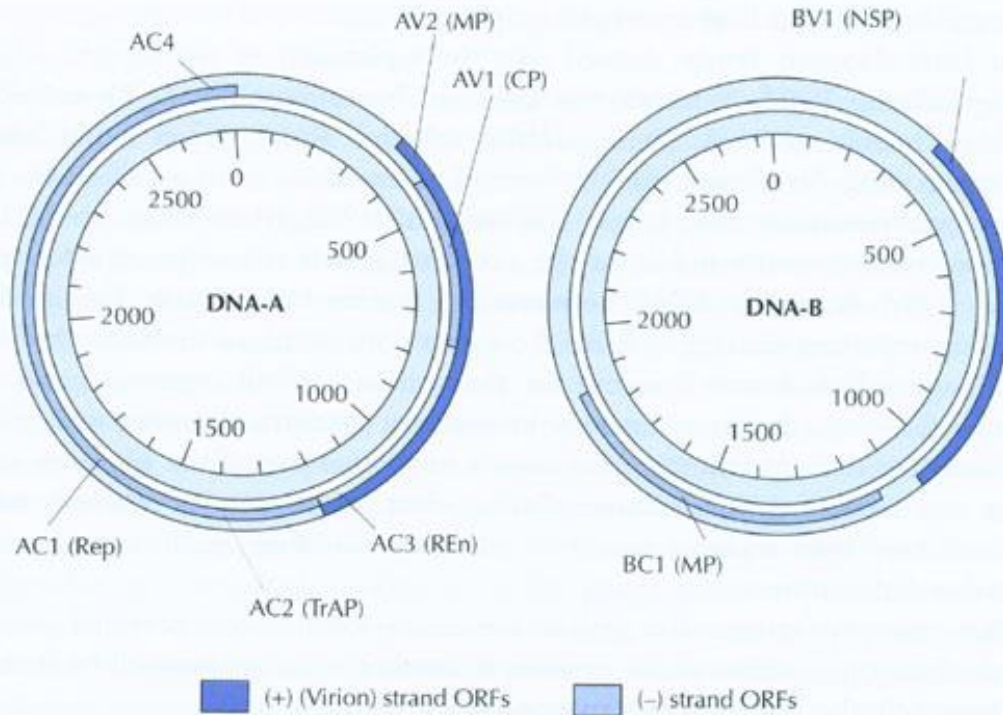

Begomovirus genome organization - components A and B, each 2,7 kb in its own half-particle, V-proteins coded on + strand, C on - strand.

DNA - phages

lytic
 elongated head,
 contractile tail



lytic/lysogenic
 isometric head,
 rigid long tail



lytic
 isometric head,
 rigid short tail



lytic
 isometric,
 minute

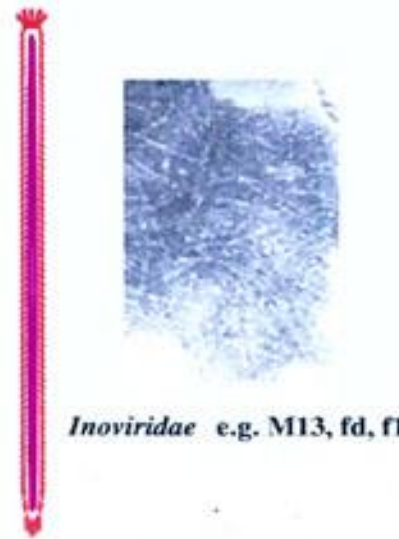

“chronic
 infections”,
 filamentous

**D
 N
 A**

Genome diversity in phages higher than in other virus groups.

Generally, high density genomes and particles, different transcription and translation strategies, high applicability of related knowledge.

Regulations – temporal and spatial (other courses).

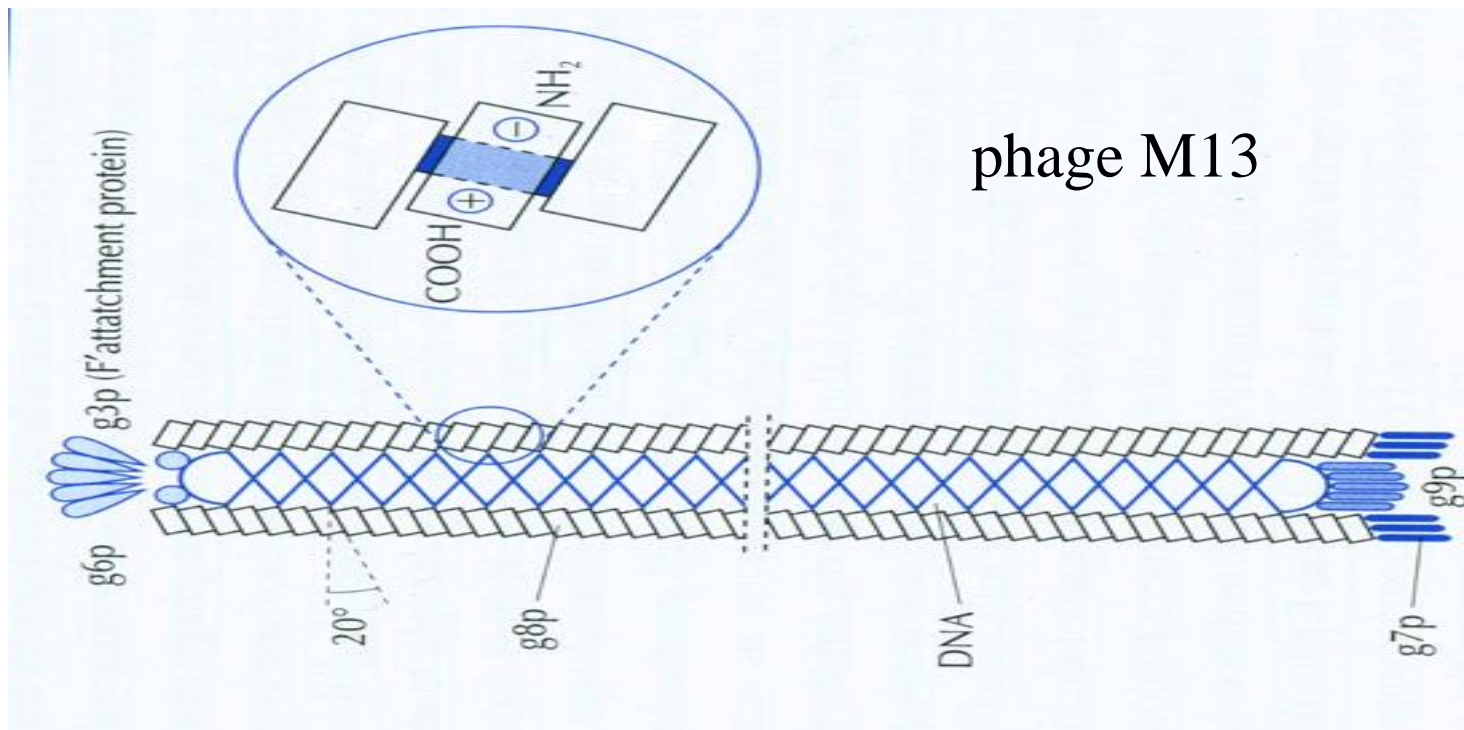

Cann, Principles of Molecular Virology, AP, 2001.

M13 cycle

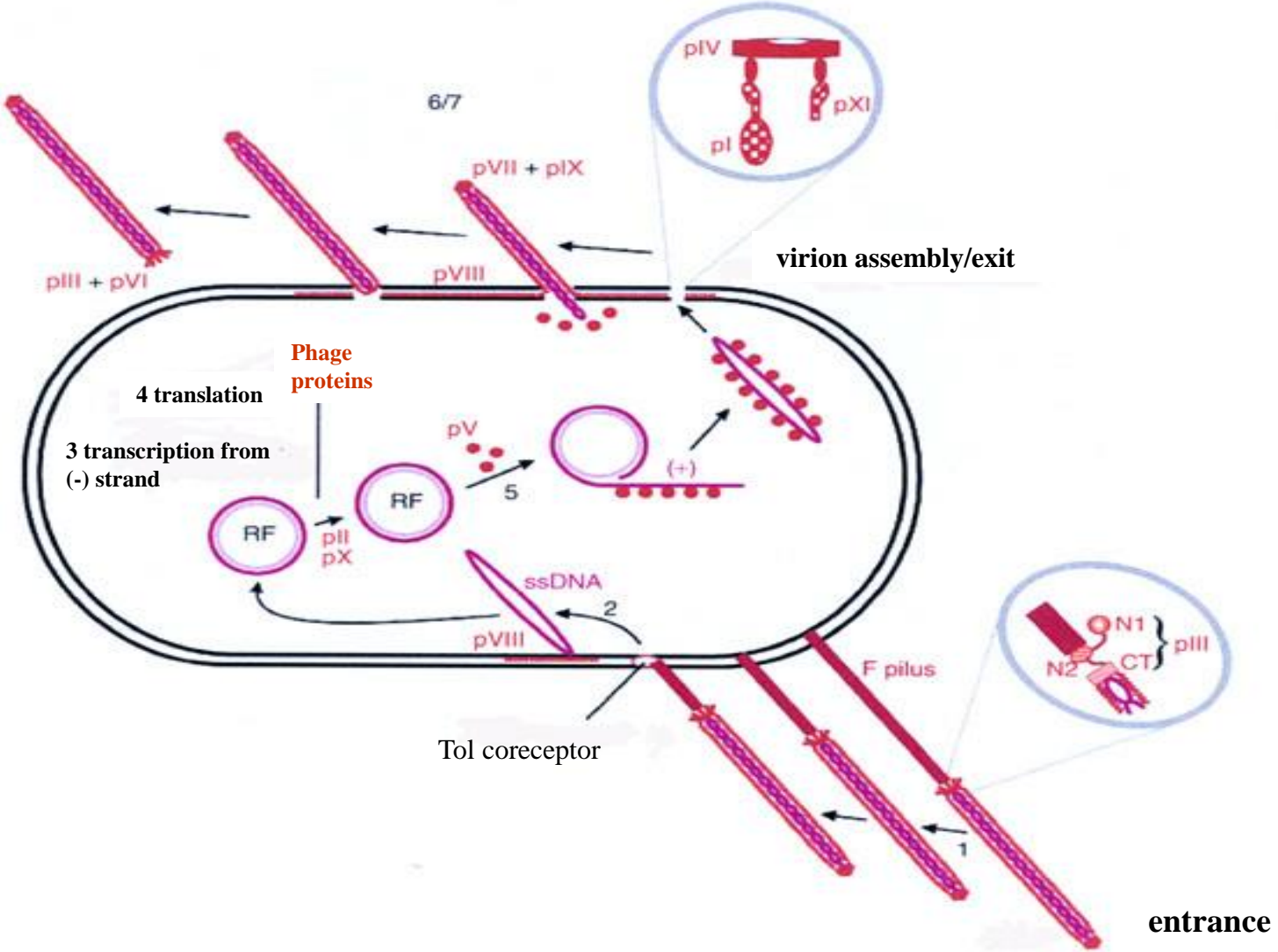

Microviridae – first evidence of overlapping genes in prokaryotes, first sequenced DNA genome, second synthetic virus

Inoviridae – androphages, high coding density, CPs are recycled, virion is assembled in the cell membrane, some can be integrated in the host genome (lysogeny).

M13-vectors, phagemids,

phage display – antibody production, protein-protein interaction research

CTX ϕ - codes cholera-toxin

Invasive meningococci have phages similar to M13.

Myo-, Sipro-, Podoviridae :

T4 – first evidence of splicing, *phage display*, nanotechnology, potential therapy of diarrhea (*E. coli*),

T7-DNA-polymerase = Sequenase™

λ -vectors, *enzymatics* (lytic phage enzymes), evolutionary (selective) advantages for bacteria.

Viruses with small DNA genomes are much more diverse regarding their genome replication strategies, transcription, translation. They include important cloning vectors, expression vectors, many are oncogenic, some can be integrated in the host genomes.