



OPĆA PALEONTOLOGIJA

5. Vježbe
Invertebrata

SEMINAR I

- Kraj svibnja ili početak lipnja
- Word i ppt
 - Max. 15 stranica (sa slikama), 15 min. izlaganja
- Pregled uzoraka nakon lekcije „Prokaryota, Protista. Mikrofacijes.”

SEMINAR I

1. UVOD

- Opisati ukratko mikropaleontološka istraživanja kao granu unutar paleontologije (razvoj, oprema, metode, neke zanimljivosti...)

2. MATERIJALI I METODE

1. OPIS DOBIVENOG MAKROUZORKA

- Litologija (boja, struktura, tekstura, sastav...)
- Stratigrafska pripadnost (ako je moguće)

2. OPIS KORIŠTENE METODE PREPARACIJE

- Izrada preparata/izbrusaka

3. REZULTATI

1. ZASTUPLJENE FOSILNE SKUPINE

- Opisati npr.: fusulinidne foraminifere, planktonske foraminifere, radiolarije, crvene alge, ostrakodi, školjkaši...

2. MIKROFACIJES

- Odrediti prema Dunhamu

4. INTERPRETACIJA

- Prema zastupljenim skupinama u uzorku/uzorcima i mikrofacijsnoj analizi probati interpretirati paleookoliš

5. KORIŠTENA LITERATURA

- Pripaziti kod navođenja
- Kod web izvora navesti poveznicu i datum pristupa, npr.:
 - The Paleobiology Database (paleobiodb.org) – pristupljeno 07.04.2026.
- Kod pisanih:
 - Kiessling, W., Flügel, E., Golonka, J. (2003): Patterns of Phanerozoic carbonate platform sedimentation. *Lethaia*, 36, 195–226.

SEMINAR I

Aljinović, D., Sremac, J., Ibrahimpasić, H. (2003): Permian and Lower Triassic facies of Velebit Mt. and Gorski Kotar region (NW part of External Dinarides). U: Vlahović, I., Tišljarić, J. (ur.): Evolution of Depositional Environments from the Palaeozoic to Quaternary in the Karst Dinarides and the Pannonian Basin. Field Trip Guidebook, 22nd IAS Meeting of Sedimentology – Opatija 2003, 185–206.

Balaž, E. (1981): Carboniferous gastropods of Lika and Velebit. *Palaeontologia Yugoslavica*, 26, 1–23.

Banner, J. L. (2004): Radiogenic isotopes: systematics and applications to earth surface processes and chemical stratigraphy. *Earth-Science Reviews*, 65, 141–149.

Barić, G. (2006): Naftna geokemija. INA Industrija nafte, Zagreb, 253 str.

Hutchins, D. A., Bruland, K. W. (1994): Grazer-mediated regeneration and assimilation of Fe, Zn and Mn from planktonic prey. *Marine Ecology Progress Series*, 110, 259–269.

Kiessling, W., Flügel, E., Golonka, J. (2003): Patterns of Phanerozoic carbonate platform sedimentation. *Lethaia*, 36, 195–226.

Schidlowski, M., (1993): The initiation of biological processes on Earth. Summary of empirical evidence. U: Engel, M. H., Macko, S. A. (ur.). *Organic Geochemistry: principles and application*. Plenum Press, New York, 639–655 str.

Sokač, B. (1973): Geologija Velebita. Doktorska disertacija, Prirodoslovno-matematički fakultet, Sveučilište u Zagrebu, 151 str.

Sokač, B., Nikler, L., Velić, I., Mamužić, P. (1974): Osnovna geološka karta SFRJ 1:100 000, list Gospić L33–127. Institut za geološka istraživanja Zagreb (1967), Savezni geološki zavod, Beograd.

Sokač, B., Ščavničar, B., Velić, I. (1976a): Osnovna geološka karta SFRJ 1:100 000, tumač za list Gospić L33-127. Institut za geološka istraživanja Zagreb, Savezni geološki zavod Beograd, 64 str.

Sokač, B., Šušnjar, M., Bukovac, J., Bahun, S. (1976b): Osnovna geološka karta SFRJ 1:100 000, tumač za list Udbina L 33–128. Institut za geološka istraživanja Zagreb, Savezni geološki zavod, Beograd, 62 str.

PARAZOA

†ARHEOCIJATIDI

SPUŽVE (Porifera)

†STROMATOPOROIDI

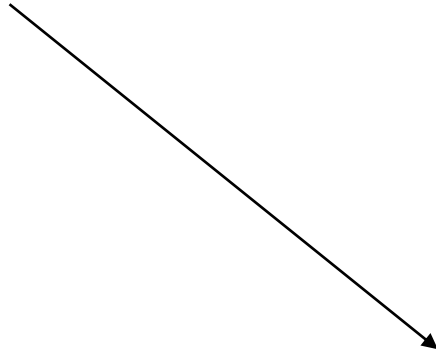
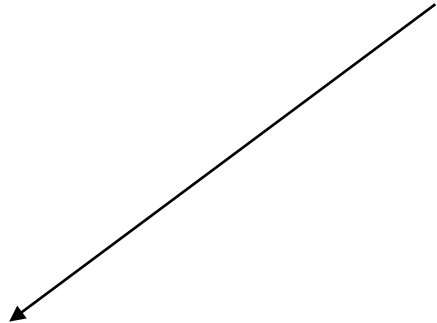

†ARHEOCIJATIDI

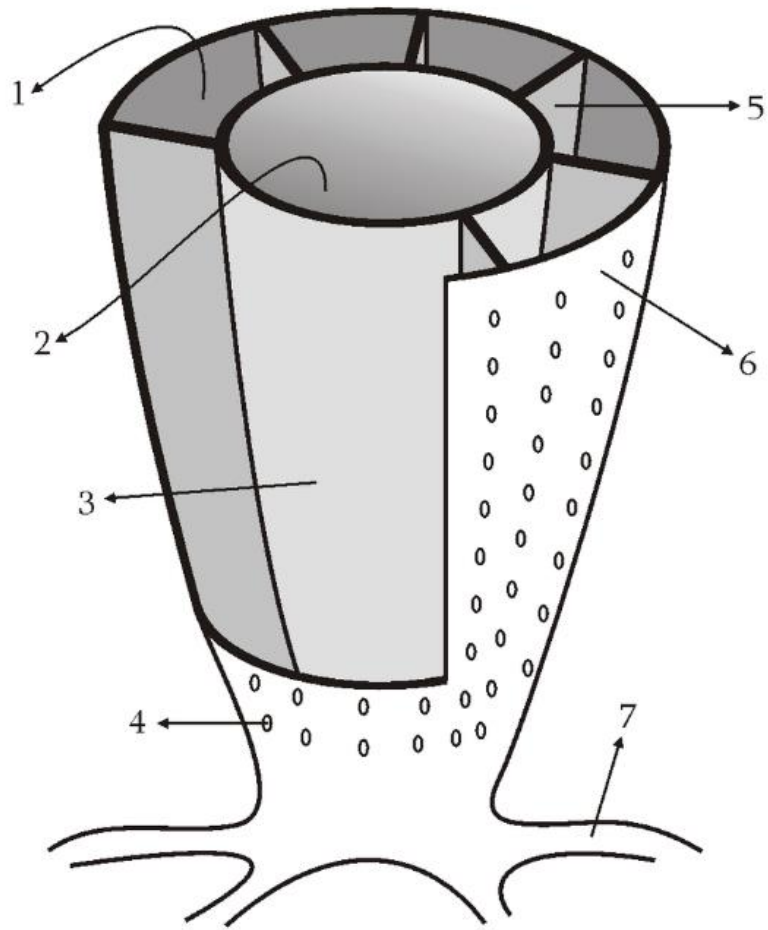

1 cm

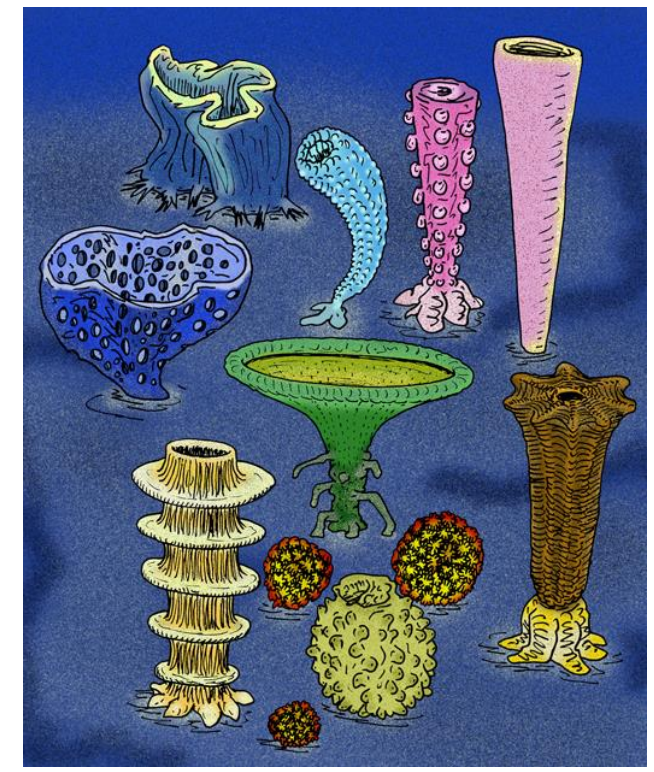

SPUŽVE (Porifera)

CALCAREA (Vapnenjače)

DEMOSPONGIAE (Kremenorožnjače)

HEXACTINELLIDA (Staklače)

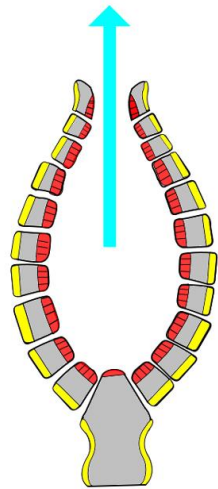

Ascon

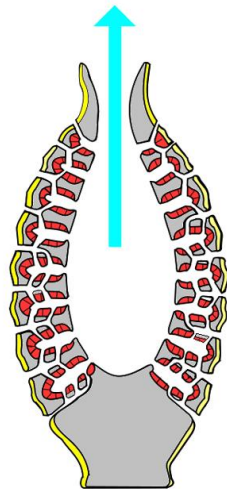

Sycon

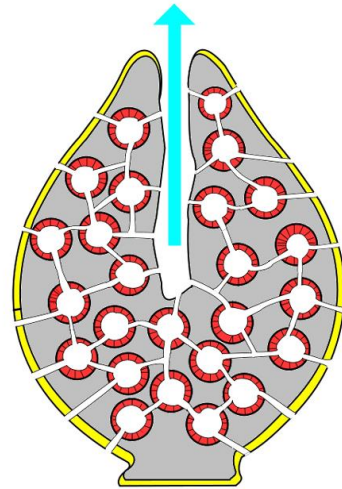

Leucon

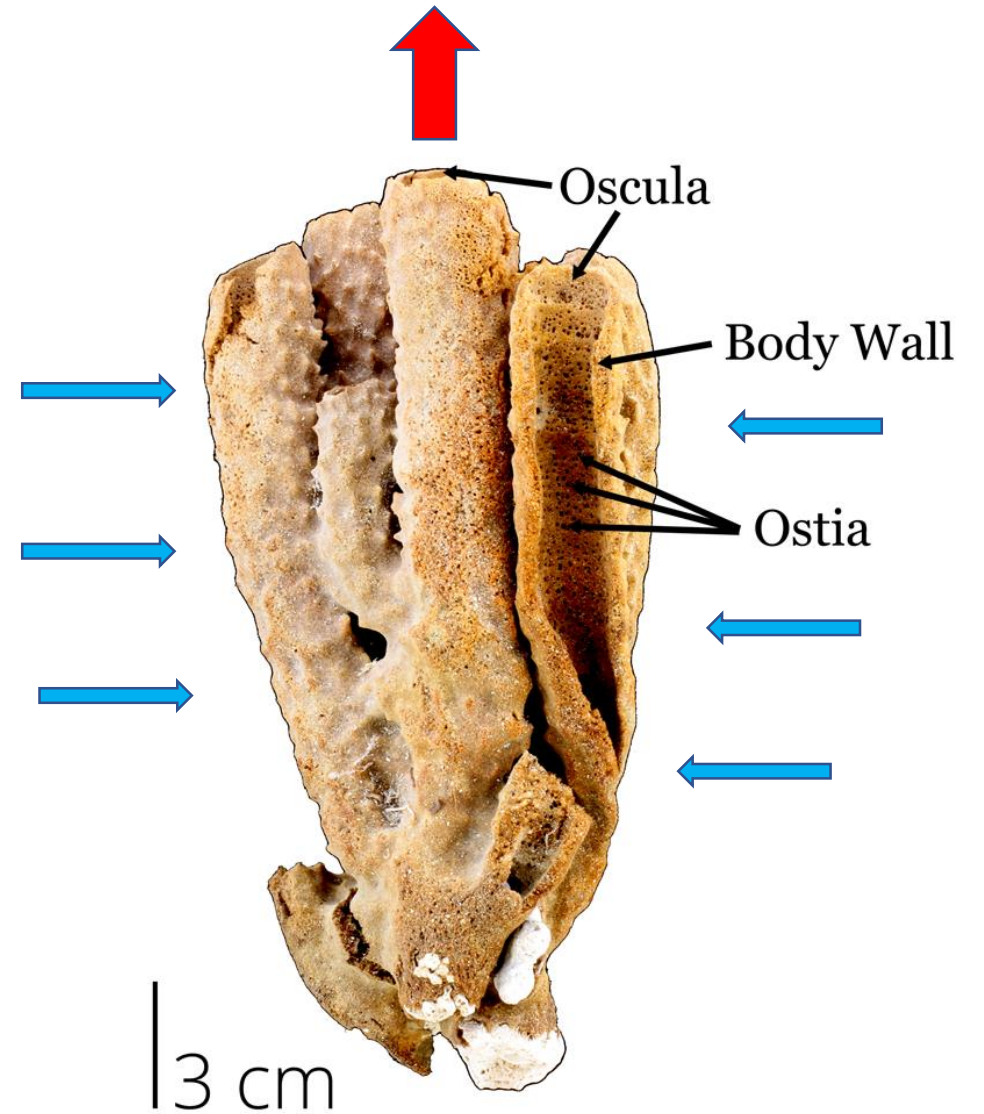

†STROMATOPOROIDI

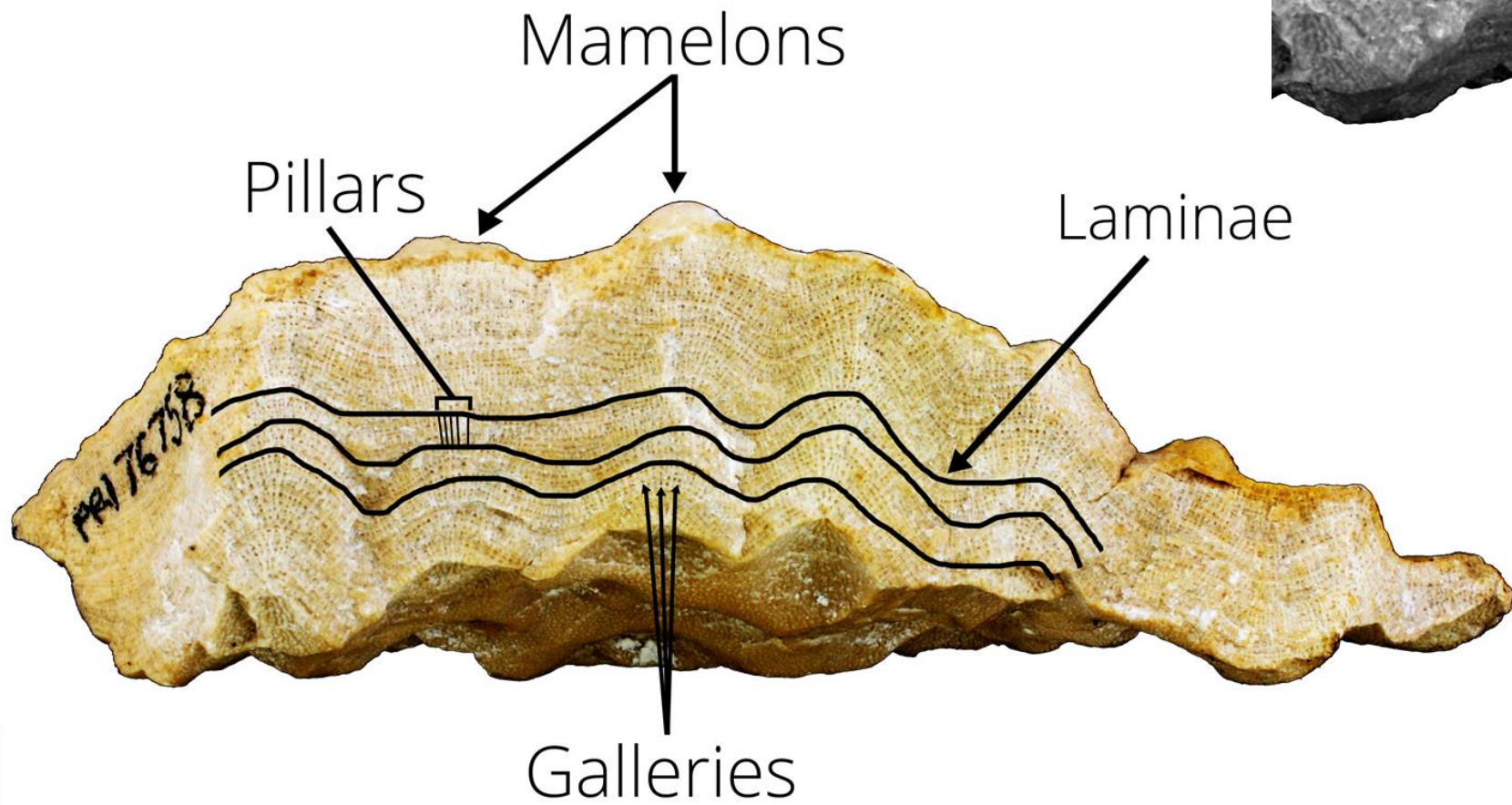
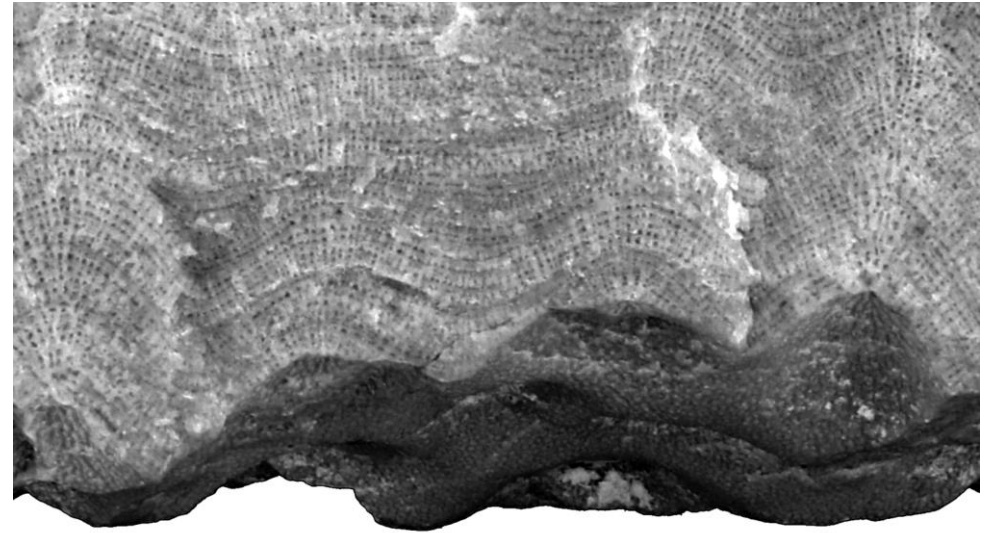

1 cm

EUMETAZOA



CNIDARIA (Žarnjaci)

ANTHOZOA (Koralji)

HYDROZOA (Obrubnjaci)

SCYPHOZOA (Režnjaci)

CUBOZOA (Kubomeduze)

ANTHOZOA (Koralji)

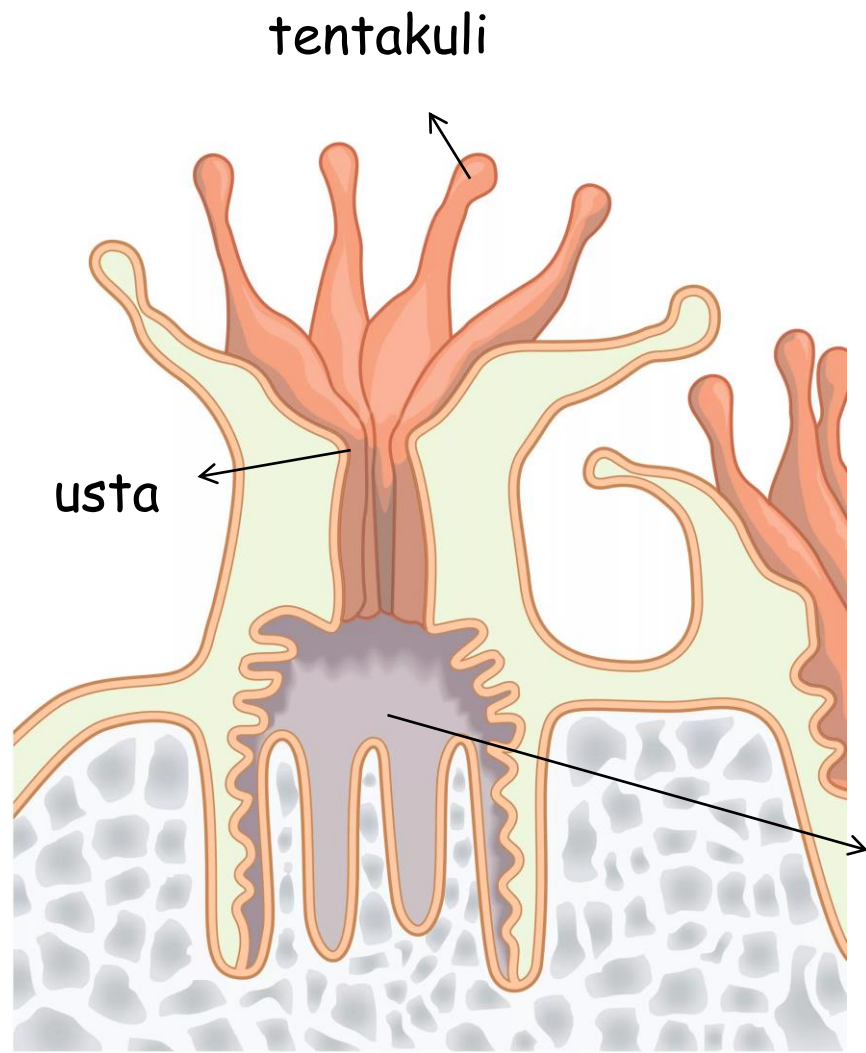

gastrovaskularna
šupljina

A yellow arrow points from the text to the gastrovascular cavity in the diagram on the left.

ANTHOZOA (Koralji)

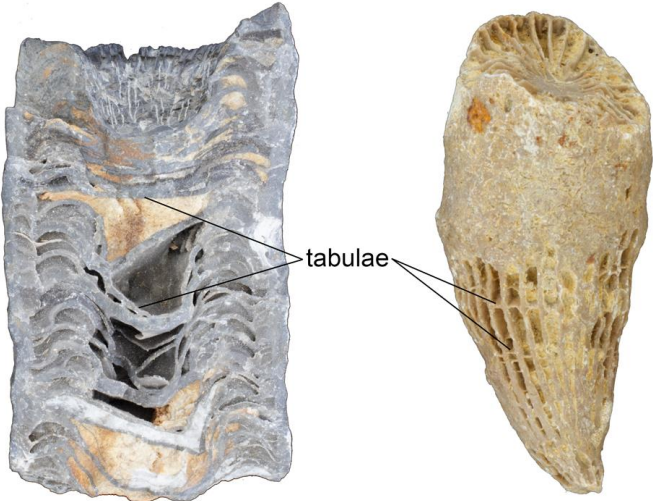

KORALUM

KORALIT

barnacles

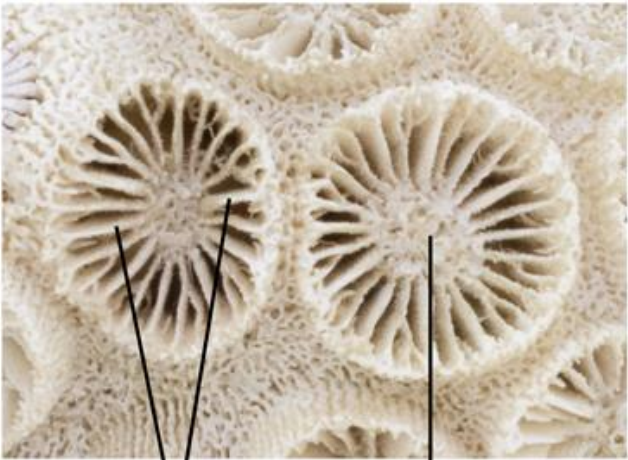
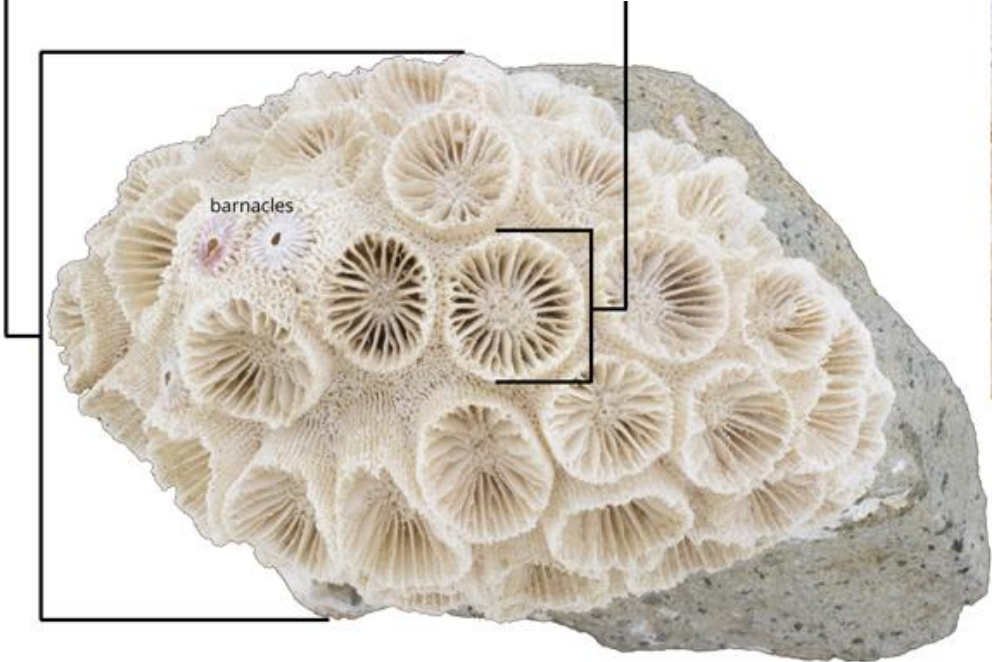

SEPTI

KOLUMELA

1 cm

†TABULATA

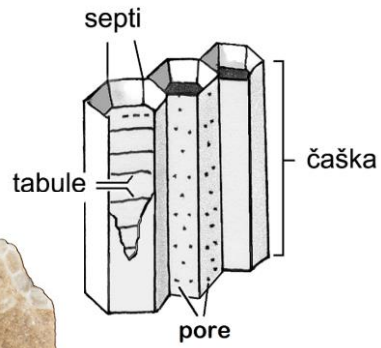

†TETRACORALLIA (RUGOSA)



Rugosa

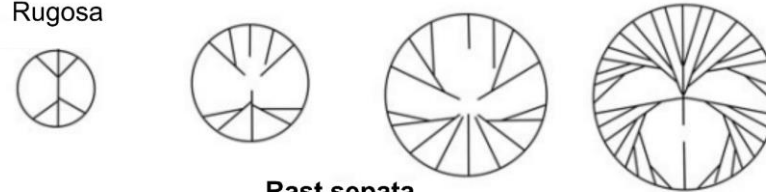

Rast sepata

HEXACORALLIA (SCLERACTINIA)



Rast sepata

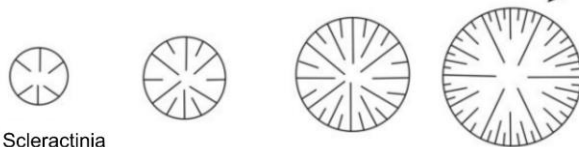

Scleractinia

OCTOCORALLIA

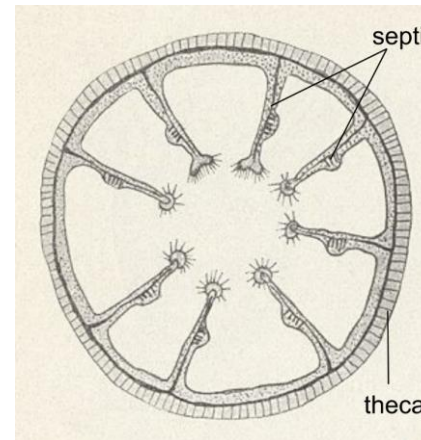

MOLLUSCA (Mekušci)

```
graph TD; MOLLUSCA[MOLLUSCA (Mekušci)] --> GASTROPODA[GASTROPODA (Puževi)]; MOLLUSCA --> BIVALVIA[BIVALVIA (Školjkaši)]; MOLLUSCA --> POLYPLACOPHORA[POLYPLACOPHORA (Mnogoljušturaši)]; MOLLUSCA --> CEPHALOPODA[CEPHALOPODA (Glavonošci)]; MOLLUSCA --> SCAPHOPODA[SCAPHOPODA (Koponošci)];
```

GASTROPODA (Puževi)

BIVALVIA (Školjkaši)

POLYPLACOPHORA (Mnogoljušturaši)

CEPHALOPODA (Glavonošci)

SCAPHOPODA (Koponošci)

BIVALVIA (Školjkaši)

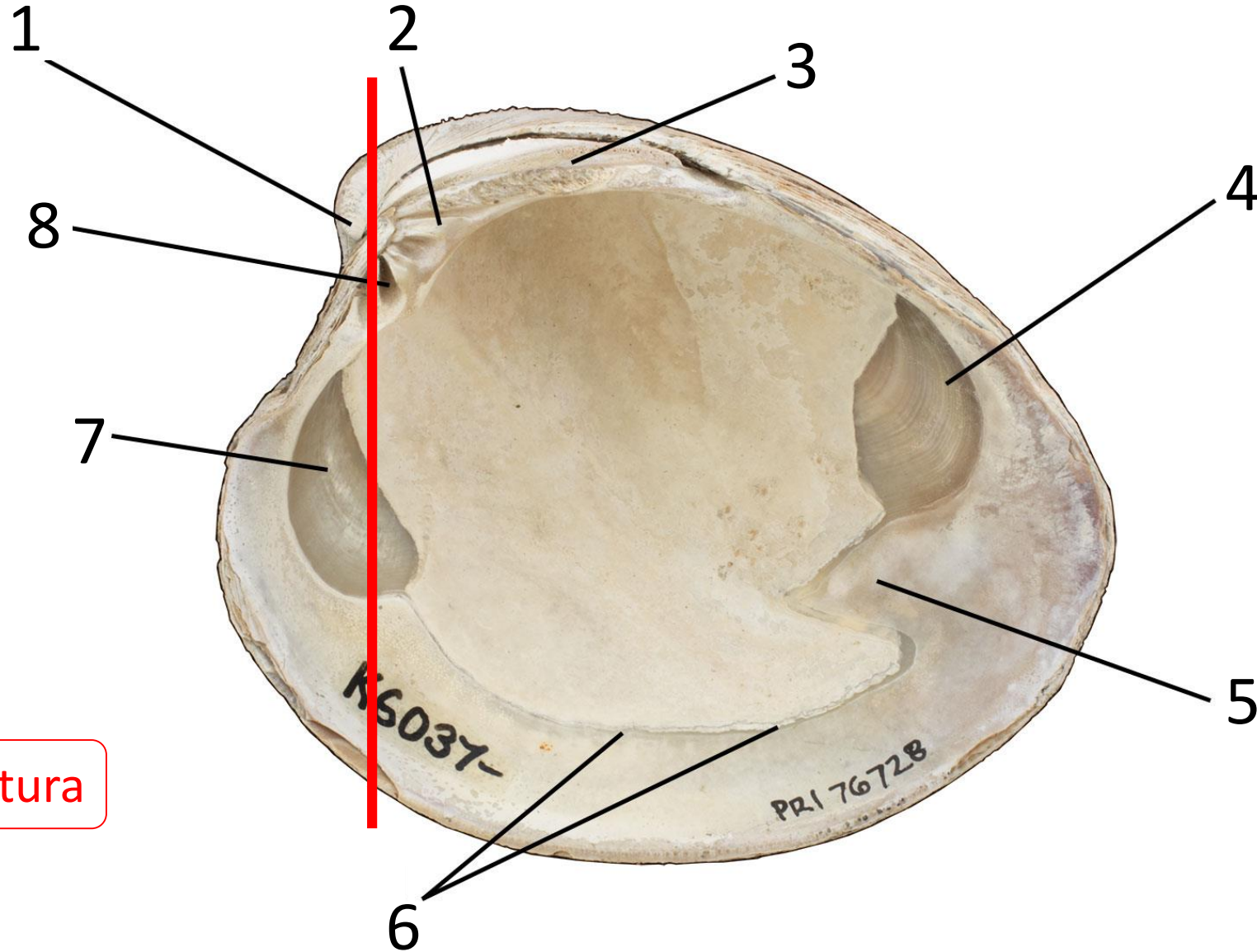

Desna ljuštura

BIVALVIA (Školjkaši)

RUDISTI



BIVALVIA (Školjkaši)

Taksodontna



Heterodontna



Schizodontna

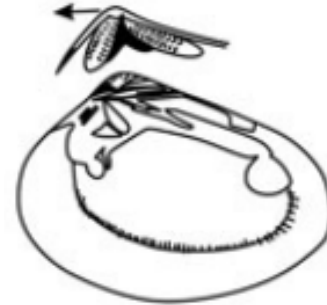

Pahiodontna



Izodontna

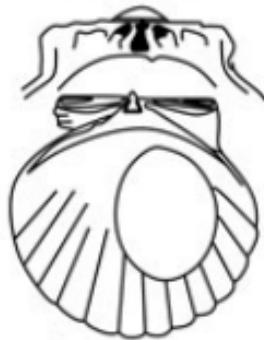

Desmodontna

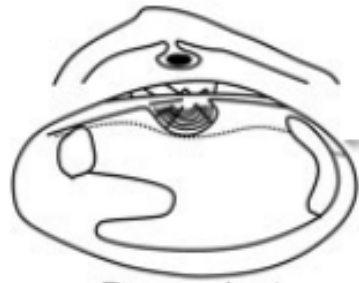

Dizodontna

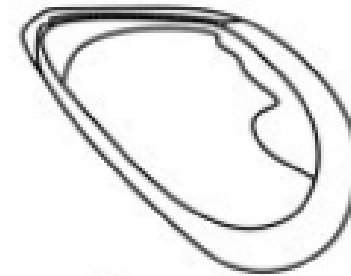

GASTROPODA (Puževi)

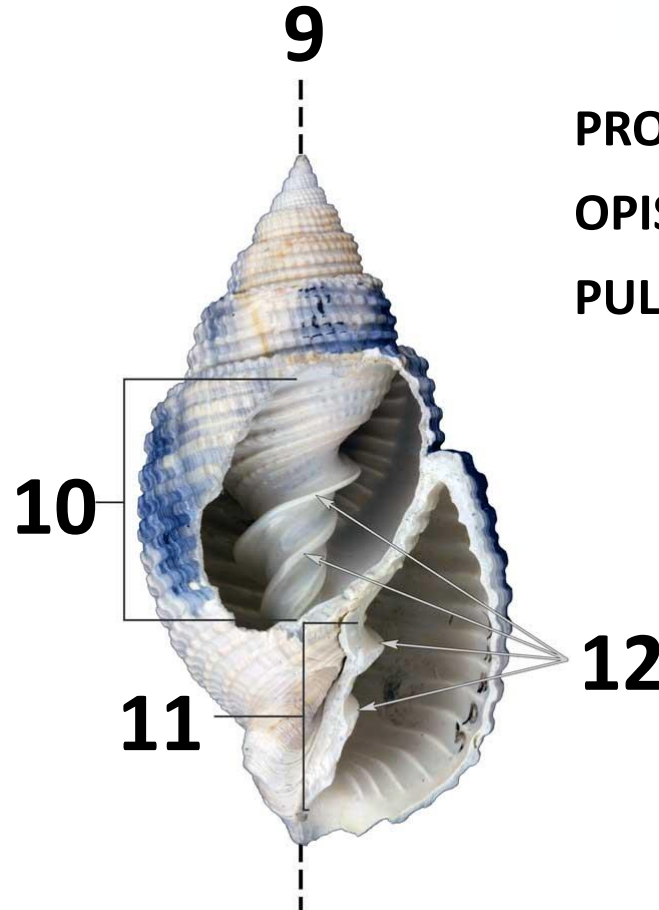
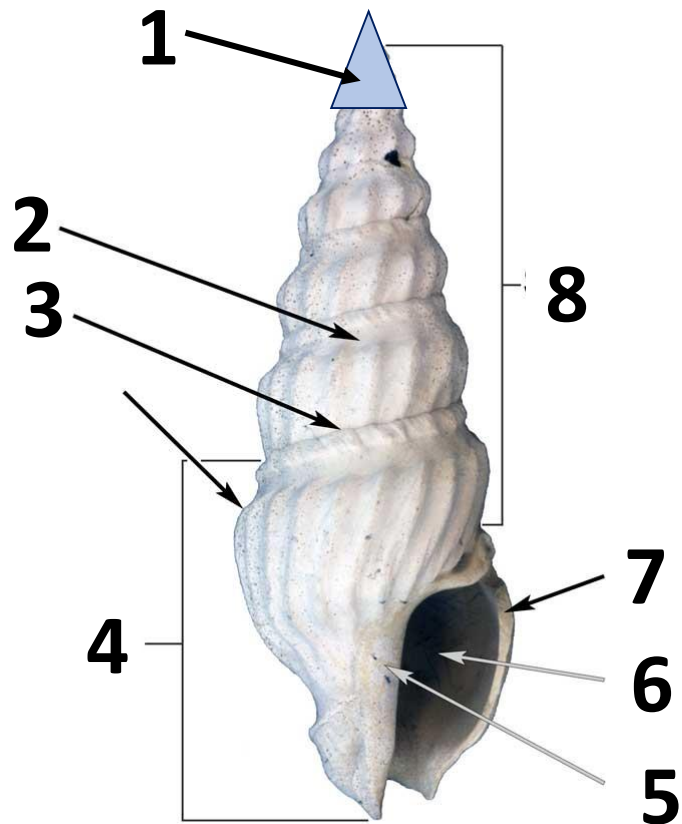
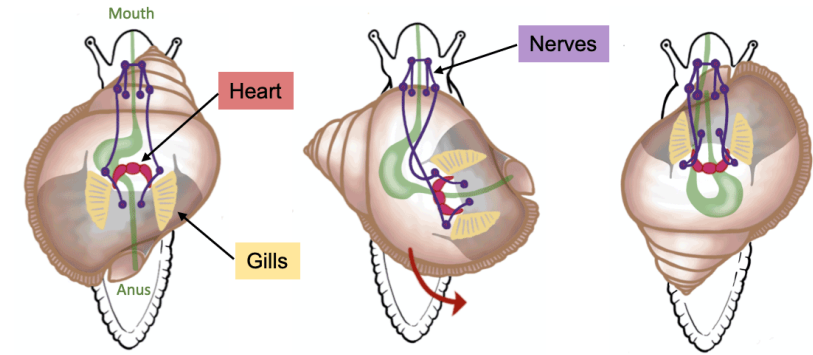

PROSOBRANCHIA (Prednjoškržnjaci)
OPISTOBRANCHIA (Stražnjoškržnjaci)
PULMONATA (Plućnjaci)

POLYPLACOPHORA (Hitoni/Mnogoljuštraši)



SCAPHOPODA (Koponošci)



MOLLUSCA (Mekušci)



CEPHALOPODA (Glavonošci)

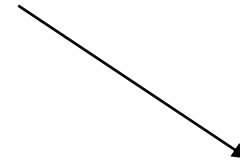
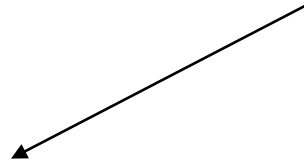

ECTOCOCHLIA (Četverškržnjaci)

Nautilidi

†Amoniti

ENDOCOCHLIA (Dvoškržnjaci)

†Belemniti

Sipe

Lignje

Hobotnice

CEPHALOPODA (Glavonošci)

NAUTILIDI

- Od kambrija do danas
- Morski organizmi
- Vanjski skelet – kućica (planispiralna, ortokonična...)
- Živjeli kao nekton, pradatori

†AMONITI

- Od devona do krede
- Morski organizmi
- Vanjski skelet – kućica (uglavnom planispiralna)
- Živjeli kao nekton, pedatori
- Odlični provodni fosili





1 cm

RAZLIKOVANJE AMONITA I NAUTILIDA

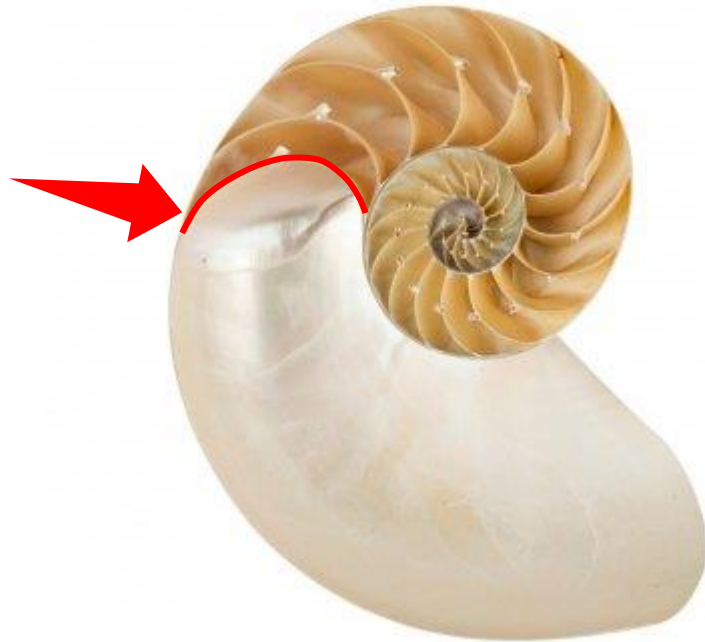

Nautilid

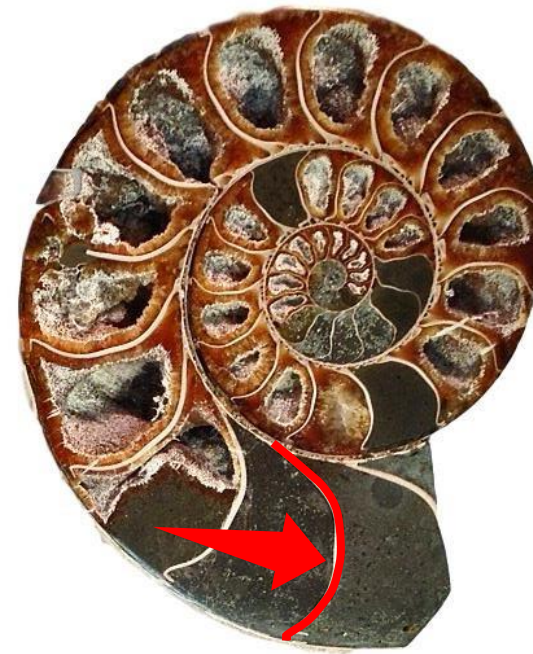

Amonit

ammonite

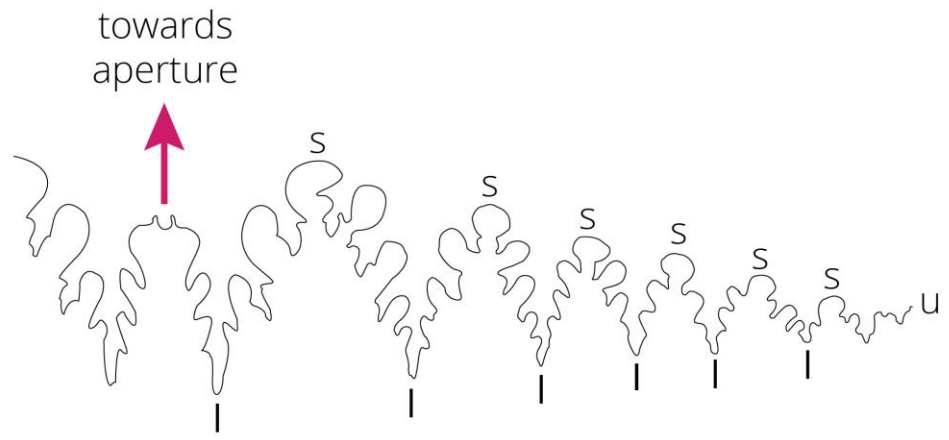

ceratite

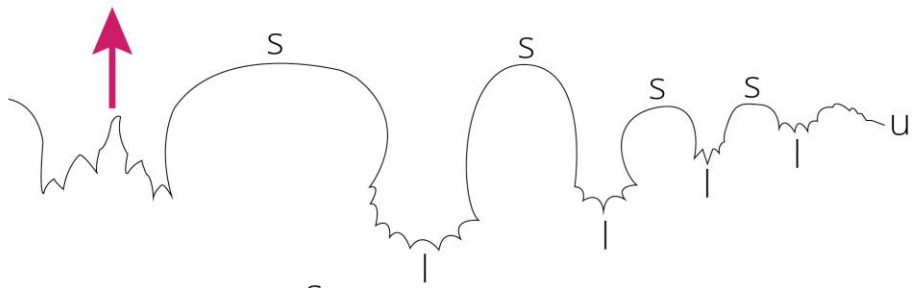

goniatite

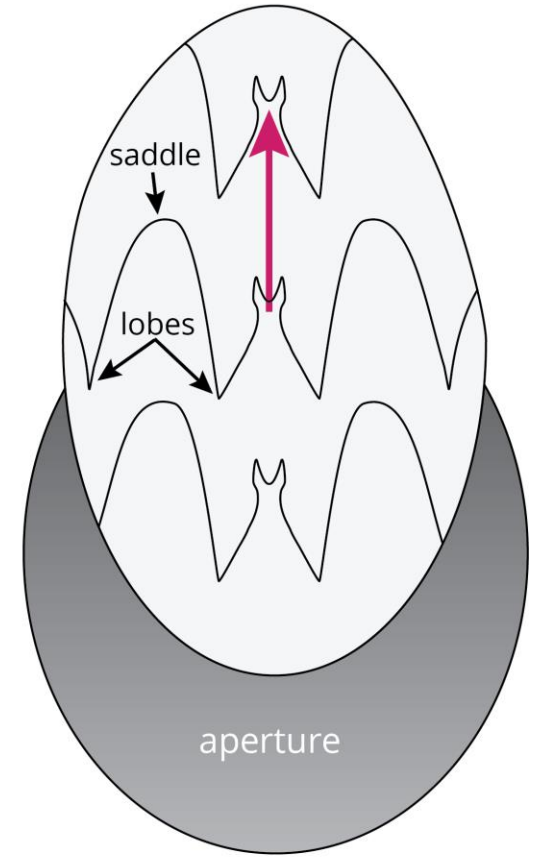
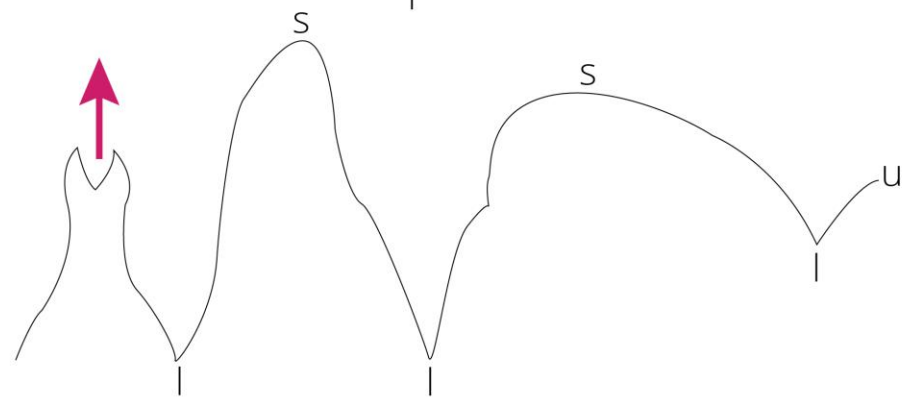

l = lobe
 s = saddle
 u = umbilicus

CEPHALOPODA (Glavonošci)

†BELEMNITI

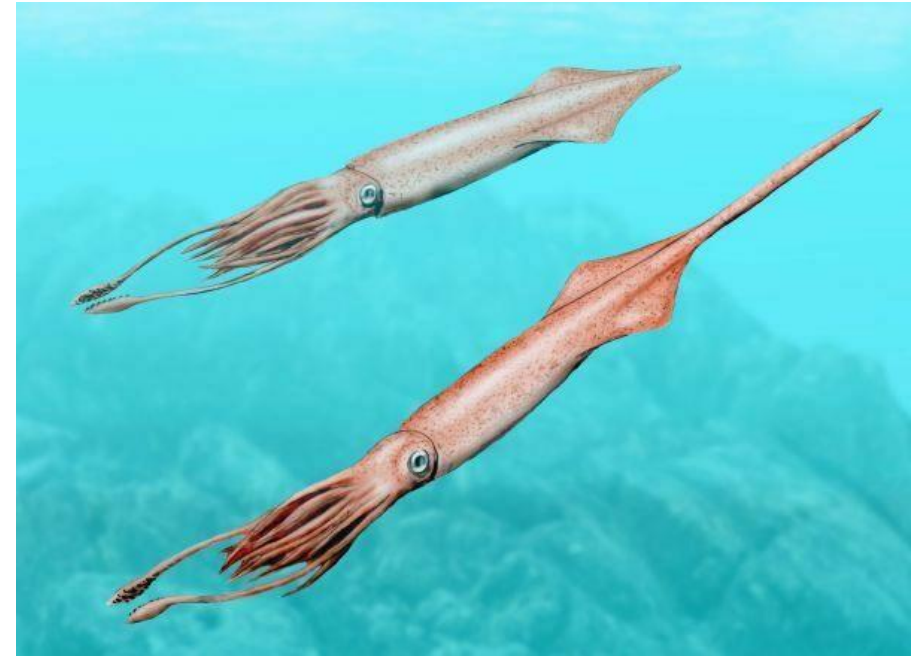
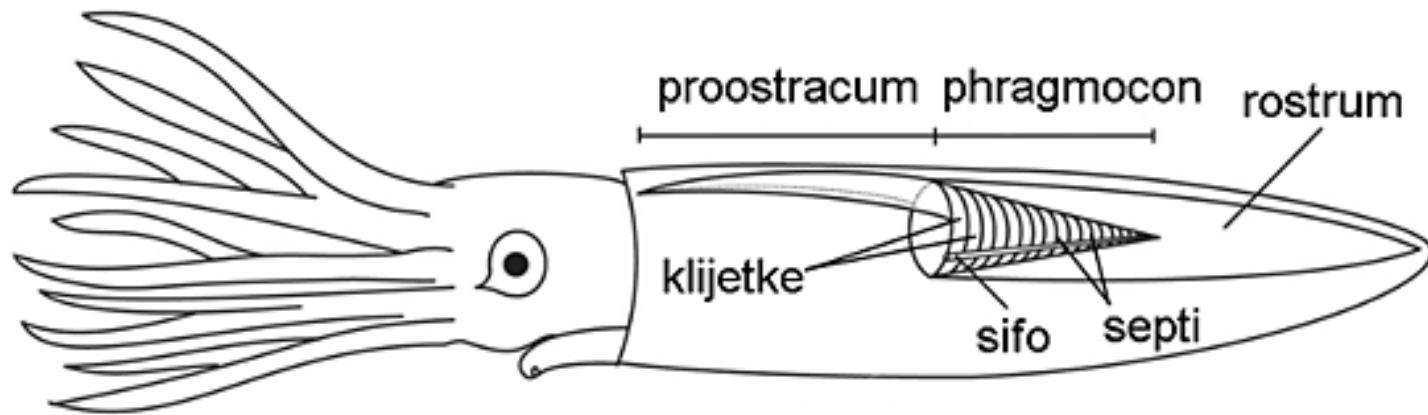

BRACHIOPODA (Ramenonošci)

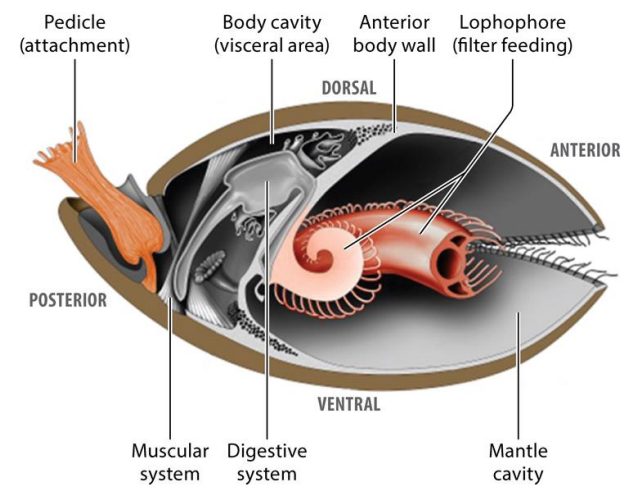
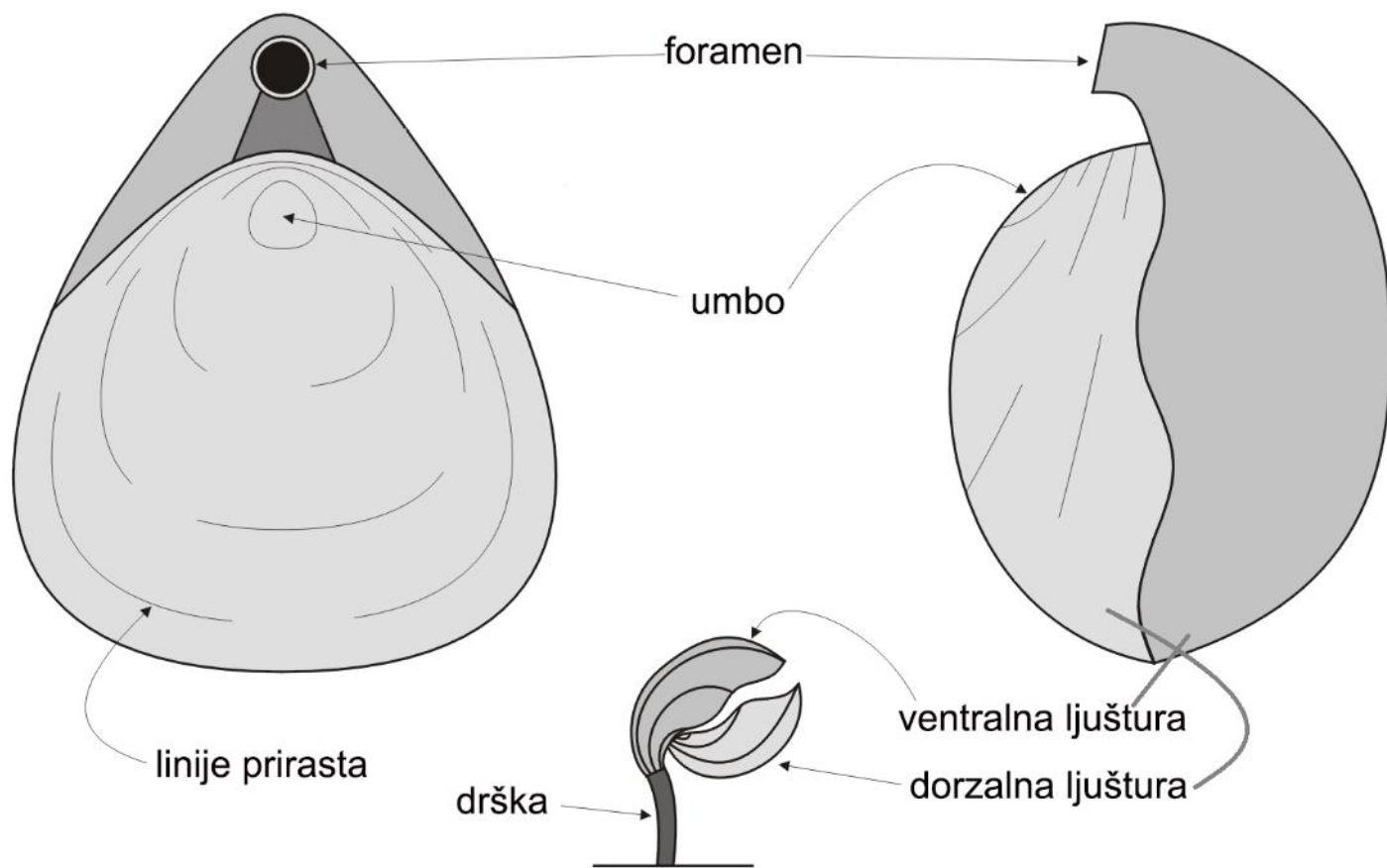

BRACHIOPODA (Ramenonošci)

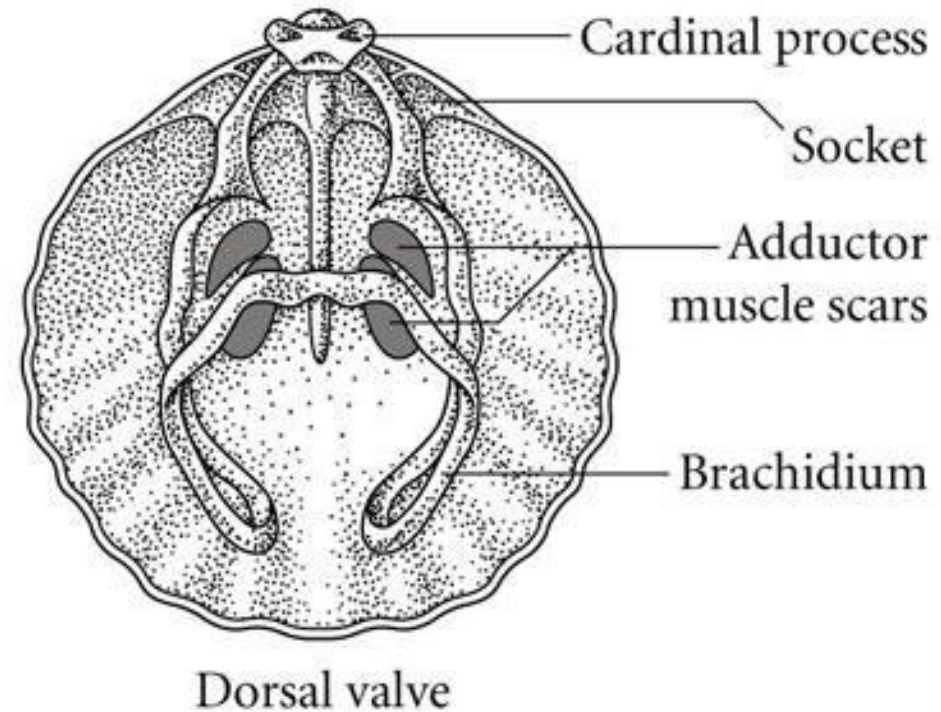
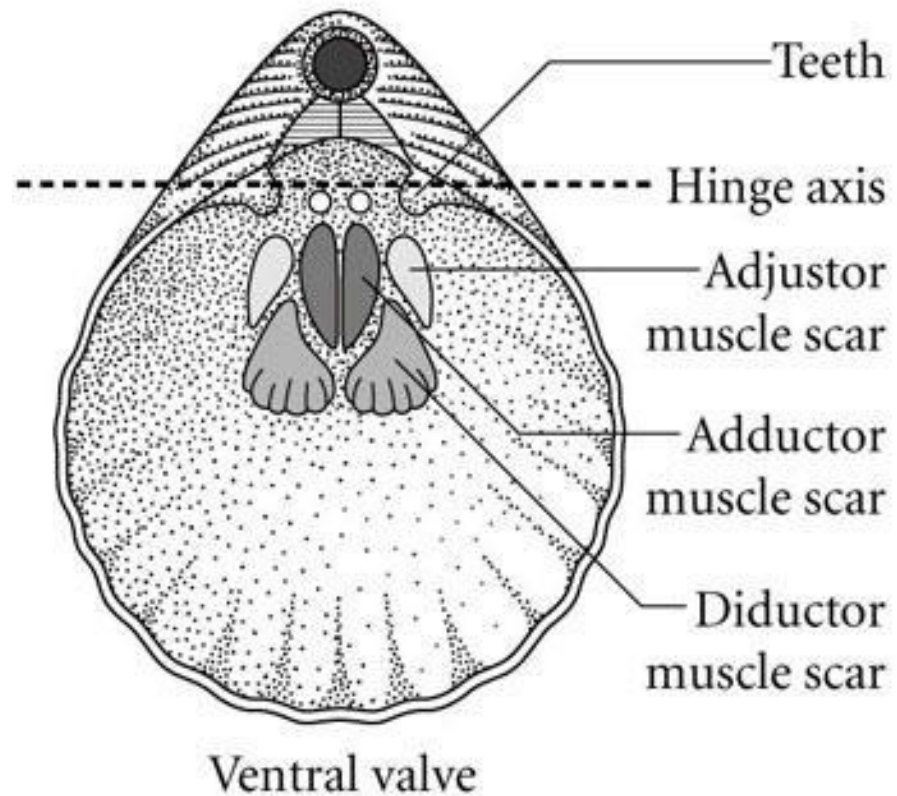

BRYOZOA (Mahovnjaci)

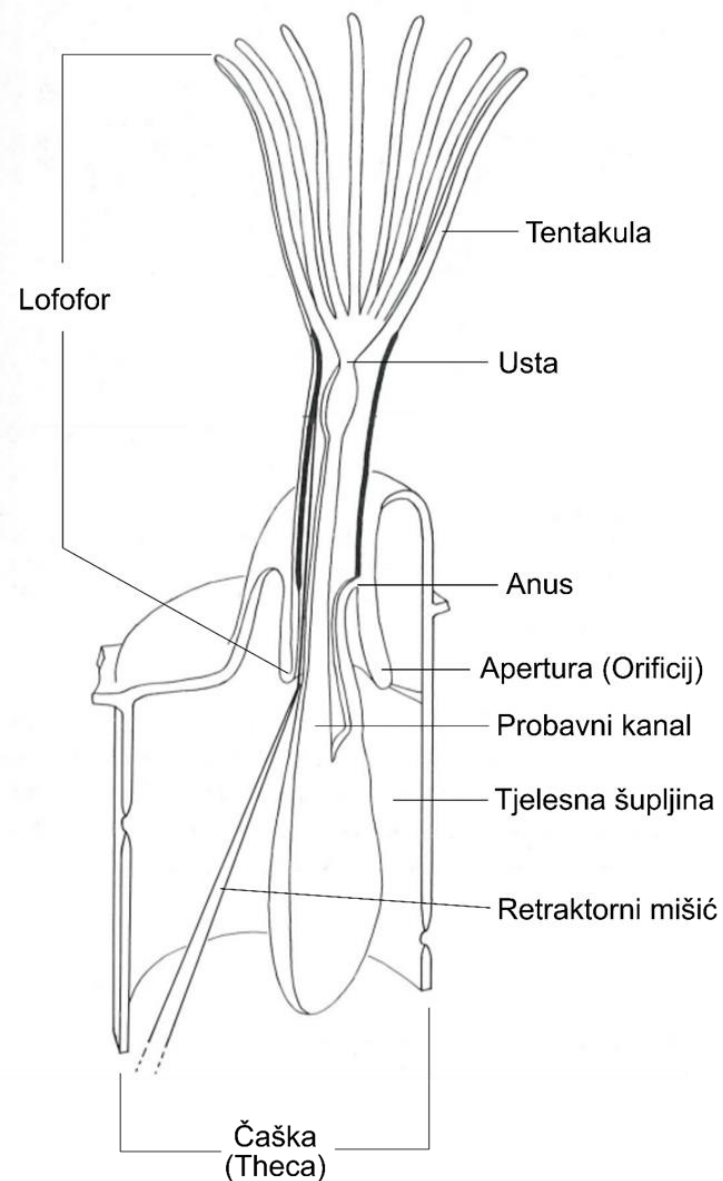
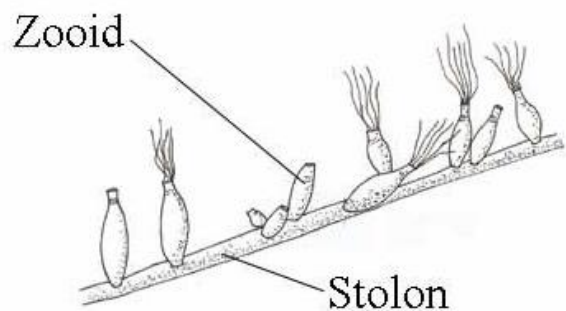
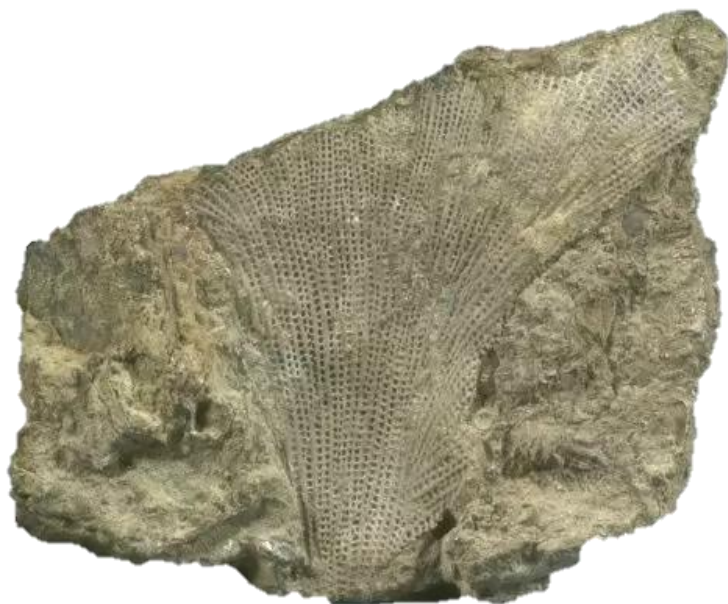

ARTHROPODA (Člankonošci)

- † TRILOBITOMORPHA (Pračlankonošci)

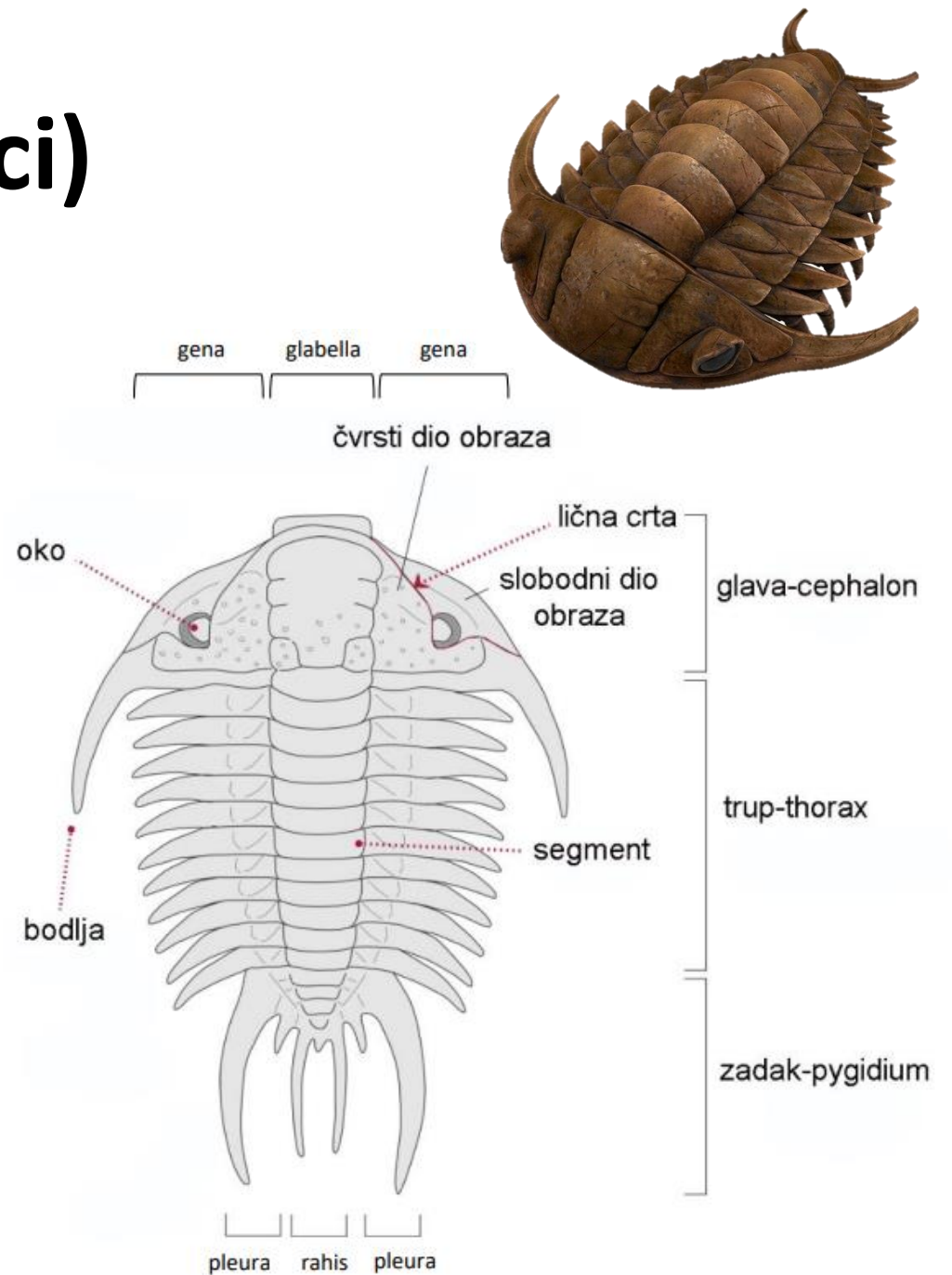
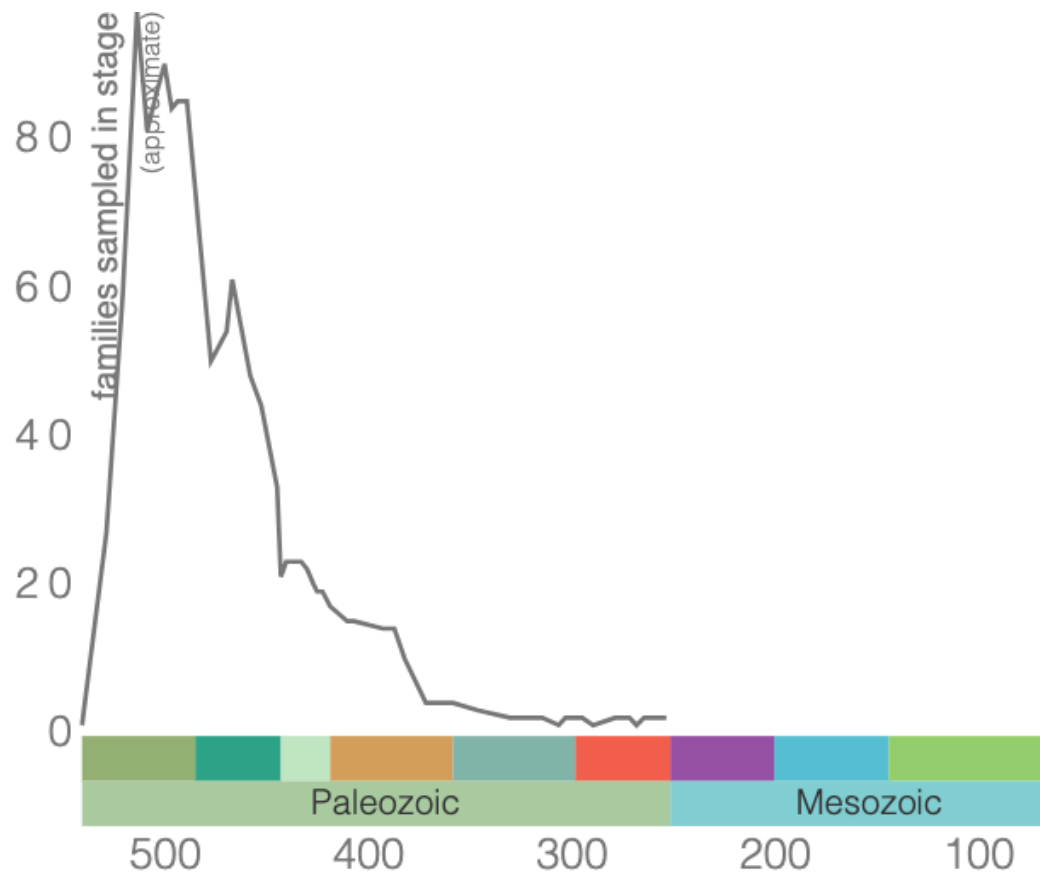

ARTHROPODA (Člankonošci)

CHELICERATA (Kliještari)



CRUSTACEA (Raci)



TRACHEATA (Uzdušnjaci)



ANNELIDA (Kolutićavci)

POLYCHAETA (Mnogočetinaši)

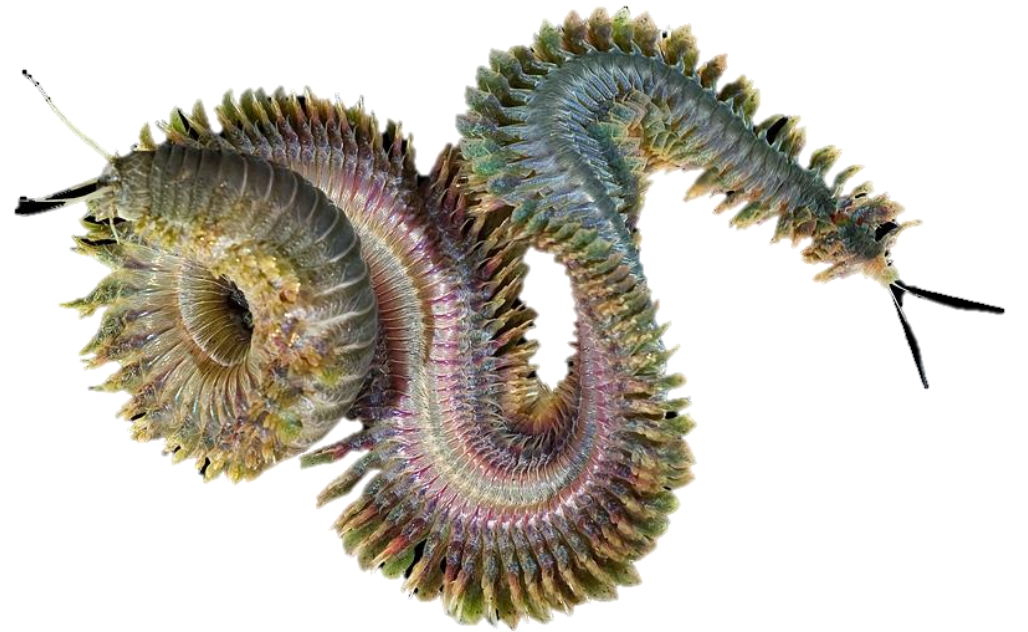



ECHINODERMATA (Bodljikaši)

STAPKOBODLJIKAŠI:
CRINOIDEA (Stapčari)

SLOBODNOBOLJIKAŠI:
ASTEROIDEA (Zvezdače)
OPHIURIOIDEA (Zmijače)
ECHINOIDEA (Ježinci)
HOLOTHUROIDEA (Trpovi)

ECHINODERMATA (Bodljikaši)

ECHINOIDEA (Ježinci)

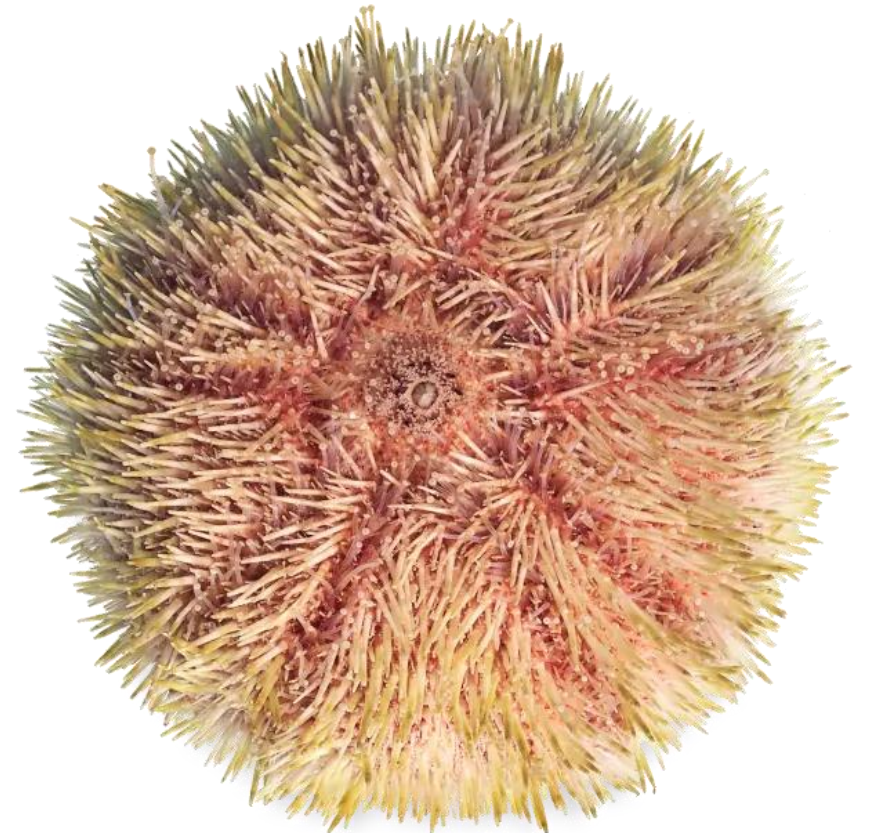

ECHINODERMATA (Bodljikaši)

REGULARIA (Pravilni)

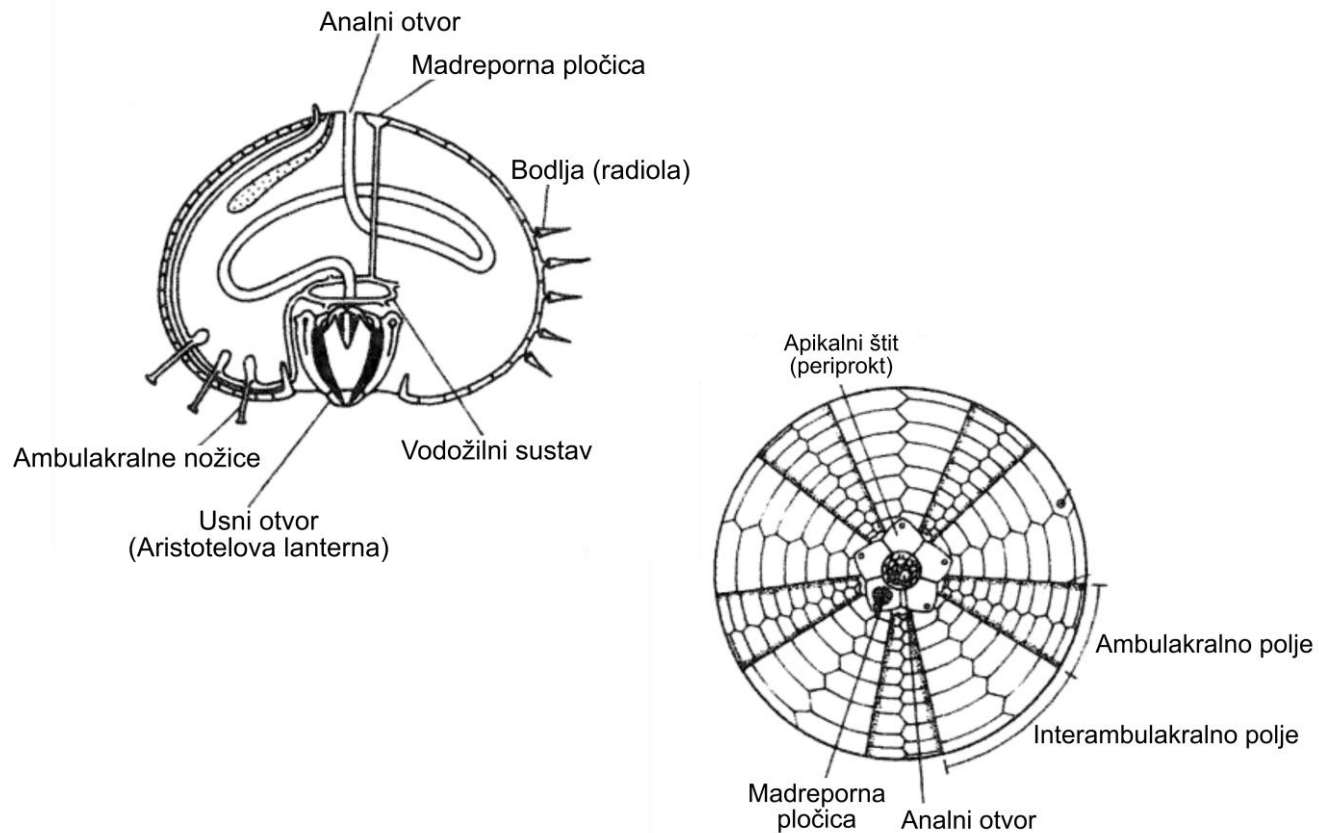

IRREGULARIA (Nepravilni)

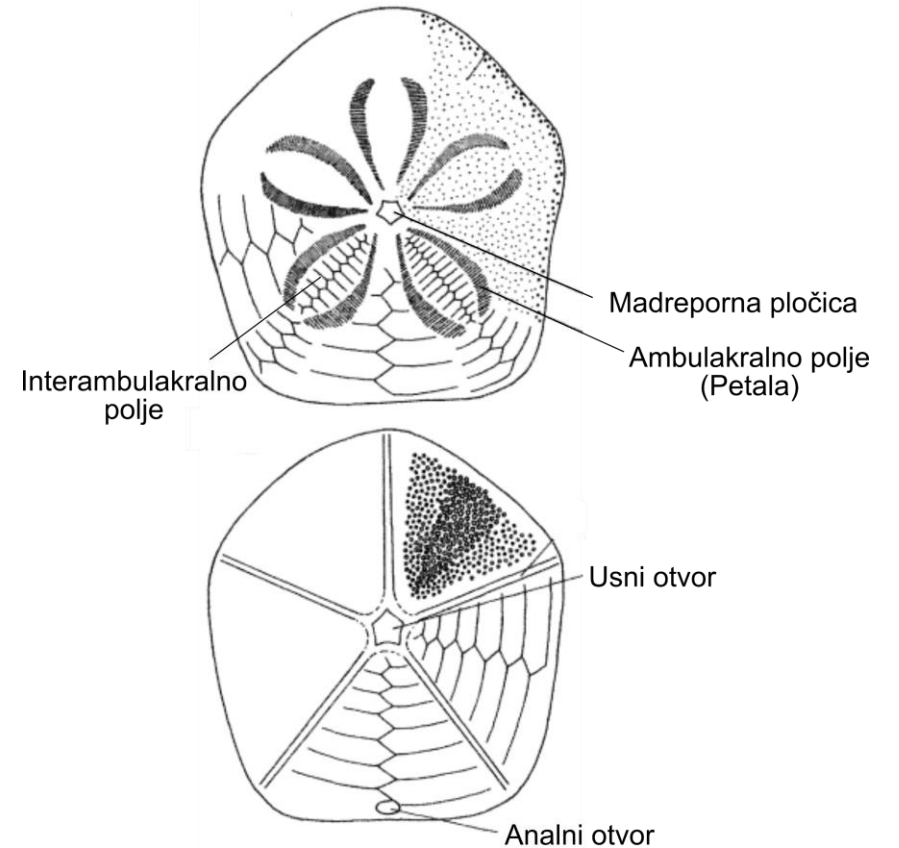

ECHINODERMATA (Bodljikaši)

CRINOIDEA (Stapčari)

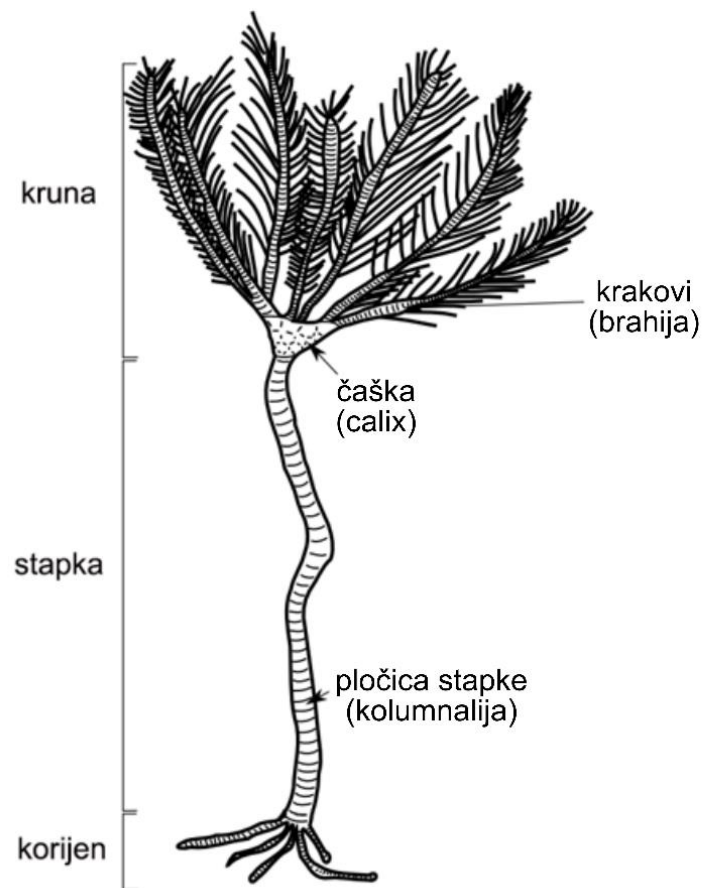

ECHINODERMATA (Bodljikaši)

ASTEROIDEA (Zvezdače)

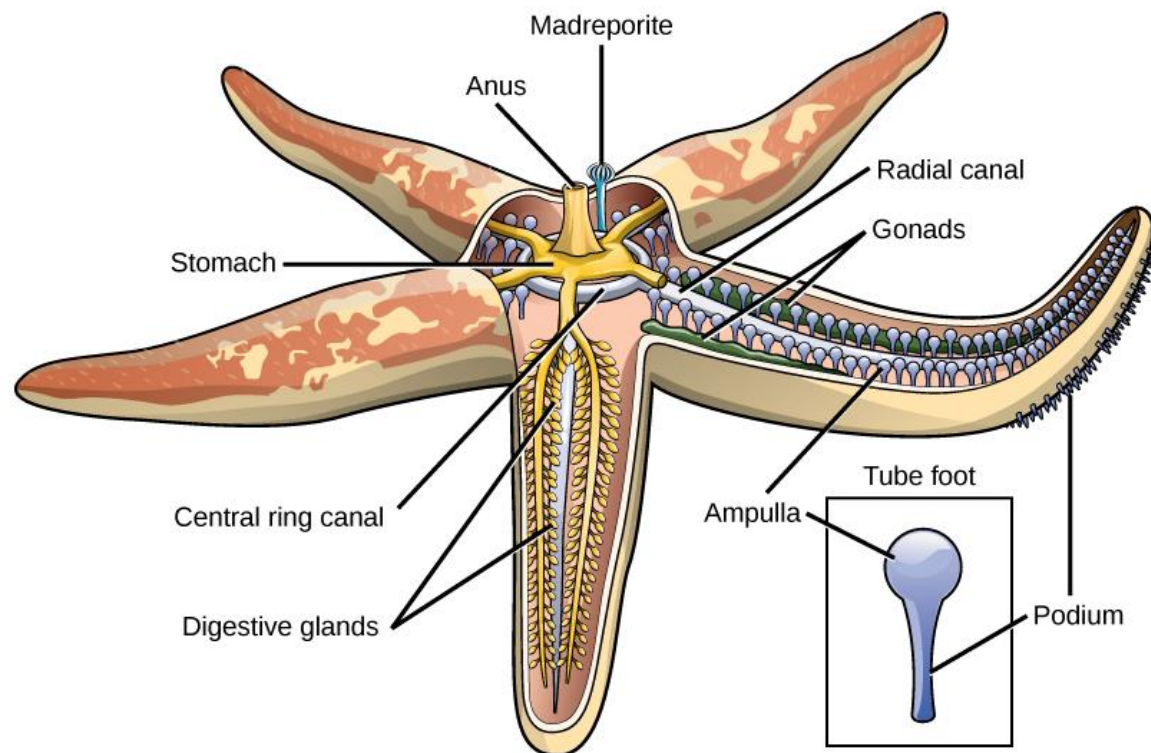

ECHINODERMATA (Bodljikaši)

OPHIURIOIDEA (Zmijače)

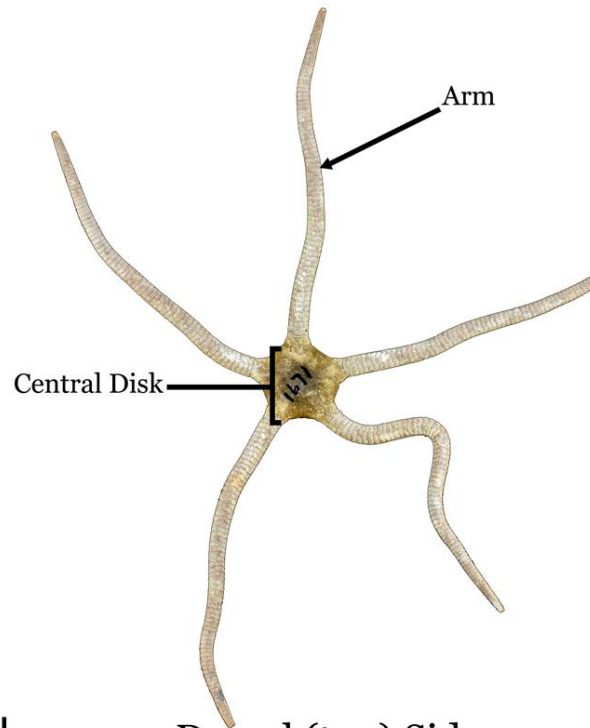

1 cm

Dorsal (top) Side

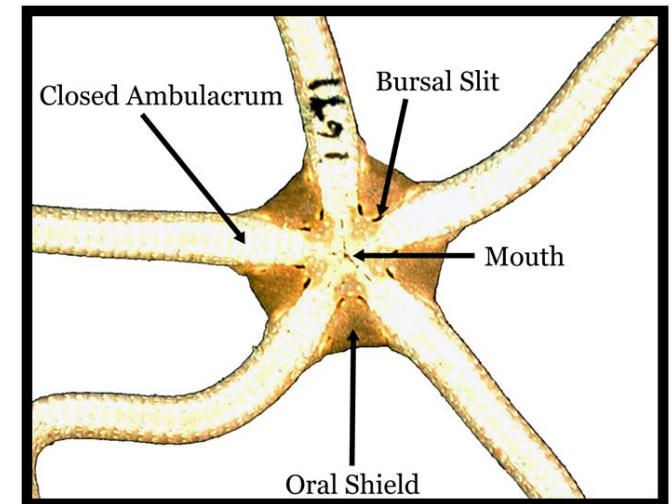

Ventral (bottom) Side

ECHINODERMATA (Bodljikaši)

HOLOTHUROIDEA (Trpovi)



usta



nožice

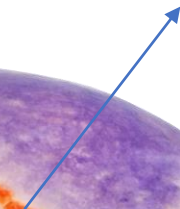

HEMICHORDATA (Polusvitkovci)

EUGRAPTOLITHINA (Graptoliti)

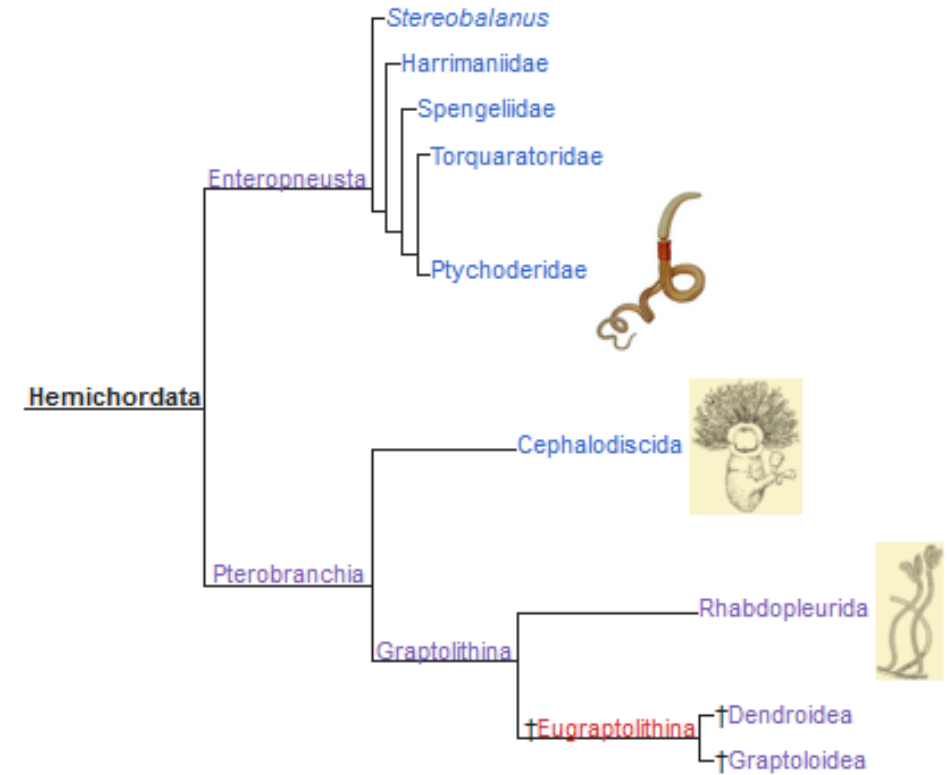
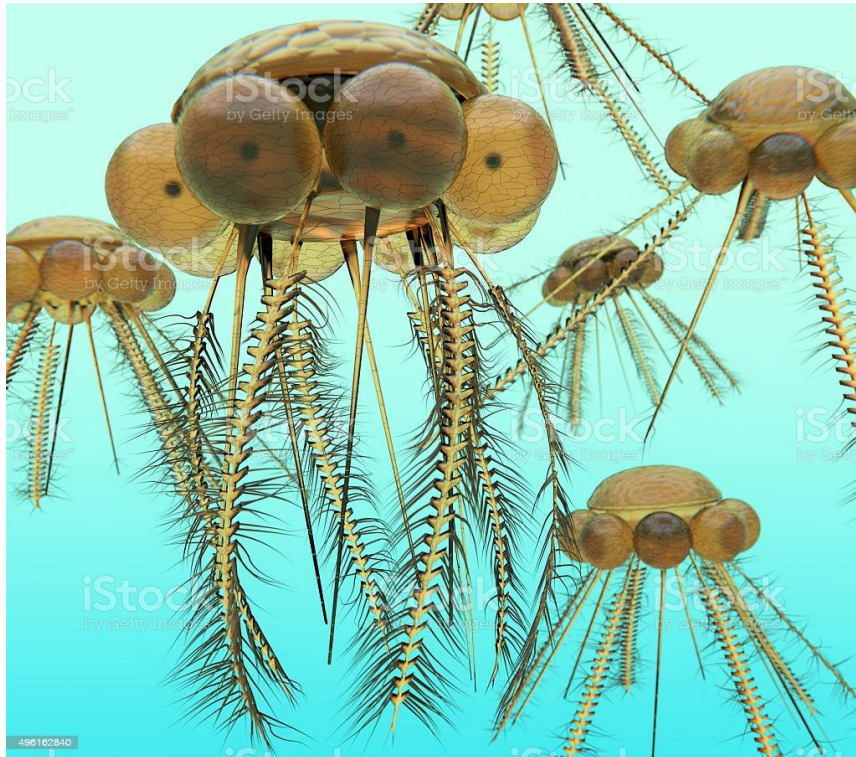

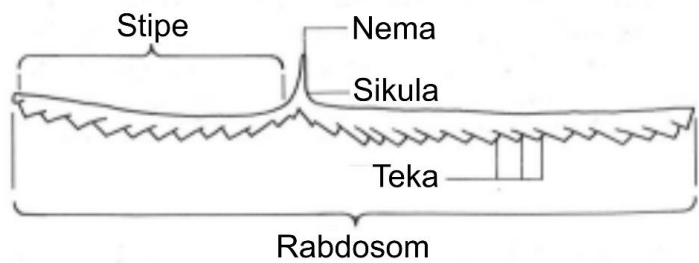
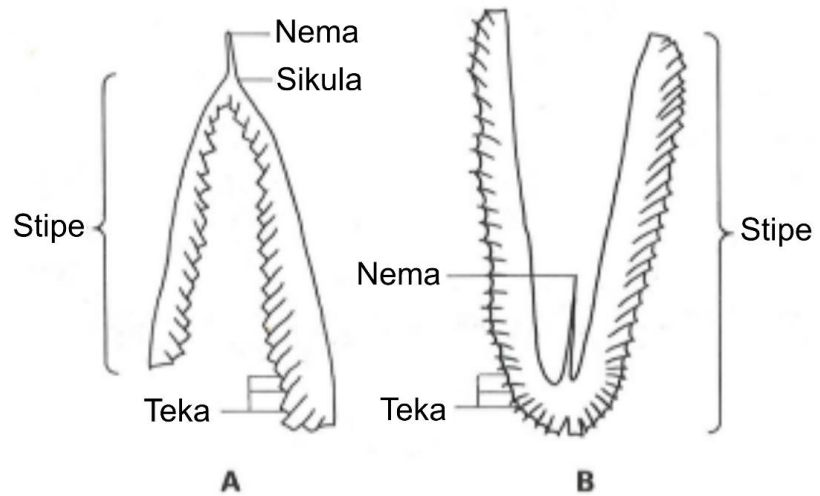

Growth vector
Stipe

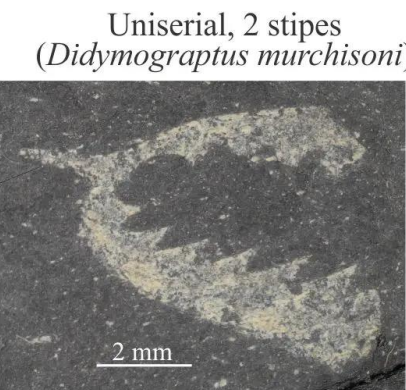
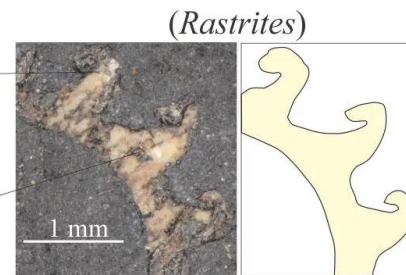
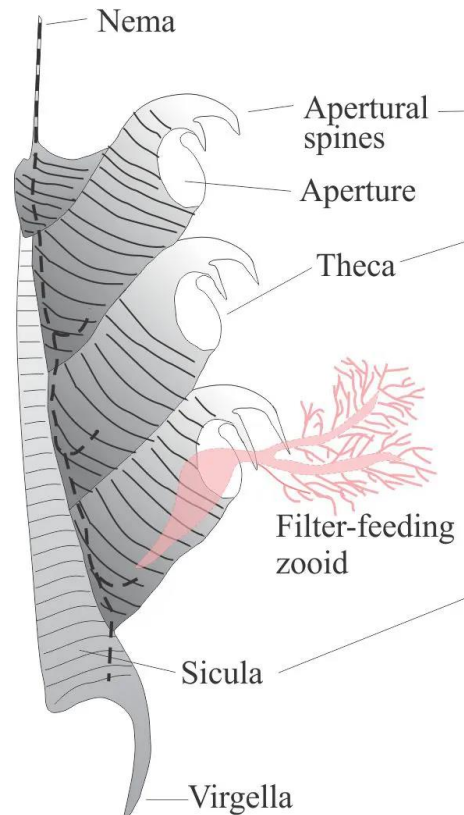

Uniserial
(*Monograptus*)



Biserial
(*Orthograptus*)

